

WOW

FLOOR TILES

perfect floors for unique spaces



CHEVRON FLOOR
Ice White Matt
HEXA FLOOR
Ice White Matt

06

Introduction / introducción

08

Triangle Floor
8"x9" / 20X23 cm

18

Hexa Floor
8"x9" / 20X23 cm

28

Trapezium Floor
4"x9" / 10X23 cm

42

Chevron Floor
8"x20,5" / 10X52 cm

56

Technical features / Información técnica

four models

infinity solutions

Choosing the right floor can prove challenging...
We present you four shapes: Trapezium, Hexa, Triangle and Chevron.
Modular to combine between them.
Each one in three colours.

Elegir el pavimento adecuado puede ser un reto...
Te presentamos cuatro formas distintas: Trapezium, Hexa, Triangle and Chevron.
Cada una disponible en tres colores.
¿Quieres ver nuestra propuesta?



TRAPEZIUM FLOOR
4"x9" / 10x23 cm



HEXA FLOOR
8"x9" / 20x23 cm



TRIANGLE FLOOR
8"x9" / 20x23 cm



CHEVRON FLOOR
4"x20,5" / 10x52 cm

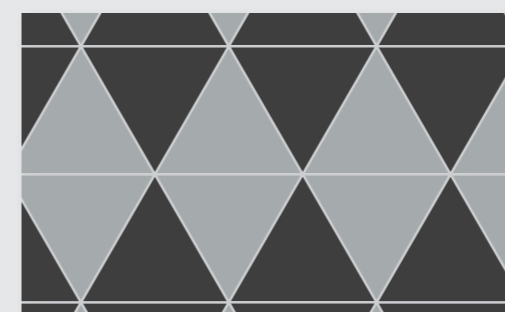
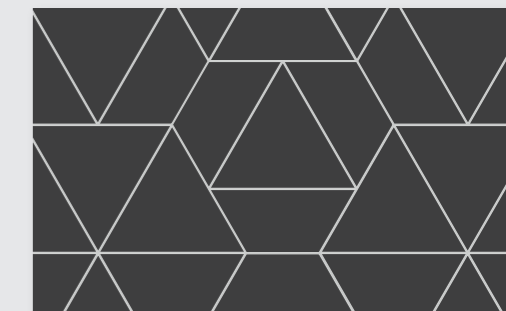

COLOUR COMBINATIONS
combinaciones de color

UNLIMITED COMPOSITIONS
composiciones infinitas

MIXED FORMATS
combinación de formatos

TRIANGLE FLOOR

8"X9" / 20X23 cm



Available colours / Colores disponibles



ICE WHITE MATT

ASH GREY MATT

GRAPHITE MATT



TRIANGLE FLOOR
Ice White Matt

WOW



COMPOSITION
composición

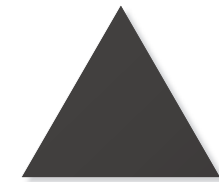

GRAPHITE MATT
57 %



GRAPHITE MATT
43 %

TRIANGLE FLOOR
Graphite Matt
TRAPEZIUM FLOOR
Graphite Matt



Floor:
HEXA FLOOR
Ice White Matt
TRIANGLE FLOOR
Ice White Matt

Wall:
NILO by WOW
Graphite Matt

COMPOSITION
composición



ICE WHITE MATT
80 %



ICE WHITE MATT
20 %

WALL TILE
composición

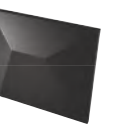

NILO by WOW
GRAPHITE MATT



COMPOSITION
composición



ICE WHITE MATT
33,3 %



ASH GREY MATT
33,3 %

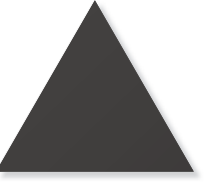

GRAPHITE MATT
33,3 %

TRIANGLE FLOOR

- . Ice White Matt
- . Ash Grey Matt
- . Graphite Matt



COMPOSITION
composición

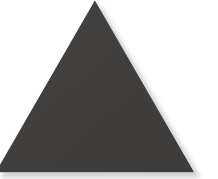

GRAPHITE MATT



ICE WHITE MATT
57 %



ICE WHITE MATT
43 %

Wall:
TRIANGLE FLOOR
Graphite Matt

Floor:
TRIANGLE FLOOR
Ice White Matt
TRAPEZIUM FLOOR
Ice White Matt

HEXA FLOOR

8"X9" / 20X23 cm



Available colours / Colores disponibles



ICE WHITE MATT



ASH GREY MATT

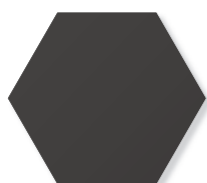

GRAPHITE MATT





COMPOSITION
composición



ICE WHITE MATT



COMPOSITION
composición

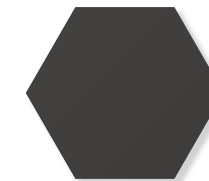

GRAPHITE MATT

WALL TILE
composición



MOON by WOW
ICE WHITE MATT

HEXA FLOOR
Graphite Matt

Wall:
MOON by WOW
Ice White Matt

WOW

COMPOSITION
composición



ASH GREY MATT

HEXA FLOOR
Ash Grey Matt





COMPOSITION
composición



ICE WHITE MATT

TRAPEZIUM FLOOR

4"X9" / 10X23 cm

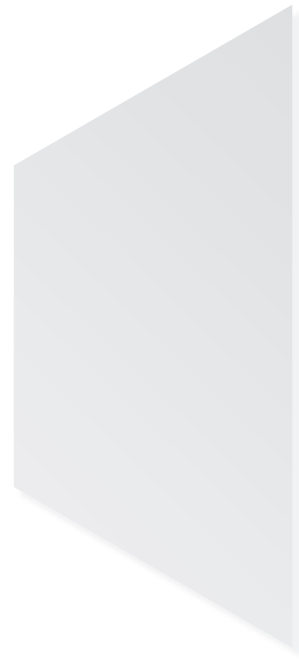

Available colours / Colores disponibles



ICE WHITE MATT

ASH GREY MATT

GRAPHITE MATT



TRAPEZIUM FLOOR
Ice White Matt
Ash Grey Matt
Graphite Matt

COMPOSITION
composición



ICE WHITE MATT

WOW



COMPOSITION
composición



ASH GREY MATT

WOW

SUSHI
レストラン

COMPOSITION
composición



ICE WHITE MATT

WALL TILE
composición



ARCH by WOW
GRAPHITE MATT

TRAPEZIUM FLOOR
Ice White Matt
ARCH by WOW
Graphite Matt



TRAPEZIUM FLOOR

Ice White Matt
Ash Grey Matt
Graphite Matt

COMPOSITION
composición



ICE WHITE MATT
42 %



ASH GREY MATT
29 %



GRAPHITE MATT
29 %

WALL TILE
composición



HEXA by WOW
ICE WHITE MATT



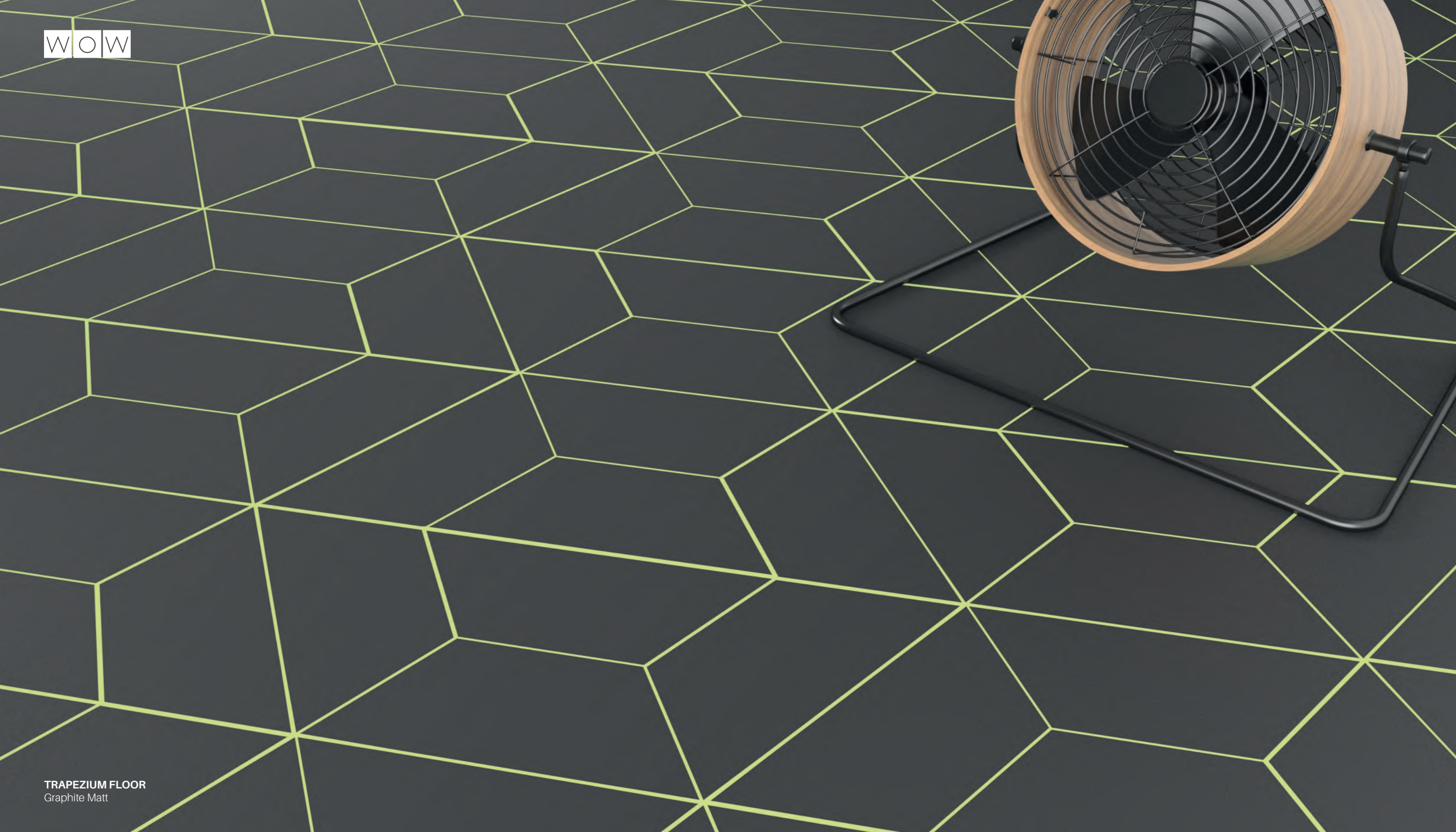

COMPOSITION
composición



GRAPHITE MATT



COMPOSITION
composición



ICE WHITE MATT
70 %



ASH GREY MATT
15 %



GRAPHITE MATT
15 %

TRAPEZIUM FLOOR
Ice White Matt
Ash Grey Matt
Graphite Matt

CHEVRON FLOOR

4"X20,5" / 10X52 cm



Available colours / Colores disponibles

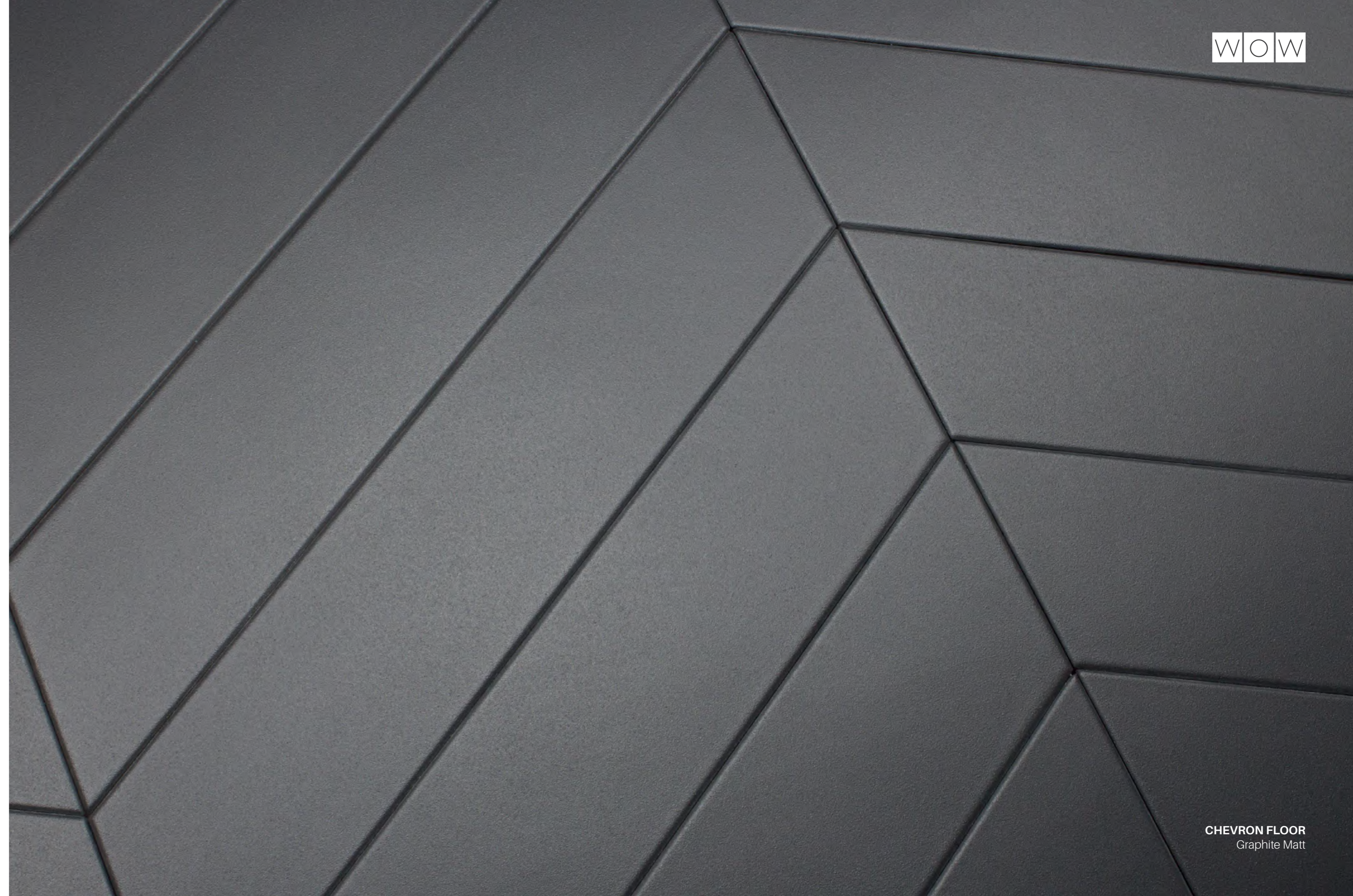



COMPOSITION
composición

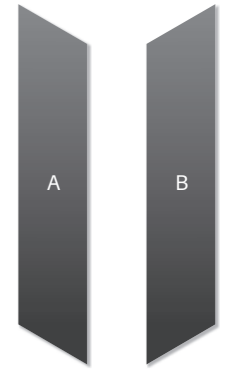

50 % 50 %
GRAPHITE MATT

WALL TILE
composición



WAVEL by WOW
ICE WHITE MATT

Floor:
CHEVRON FLOOR
Graphite Matt

Wall:
WAVE by WOW
Ice White Matt

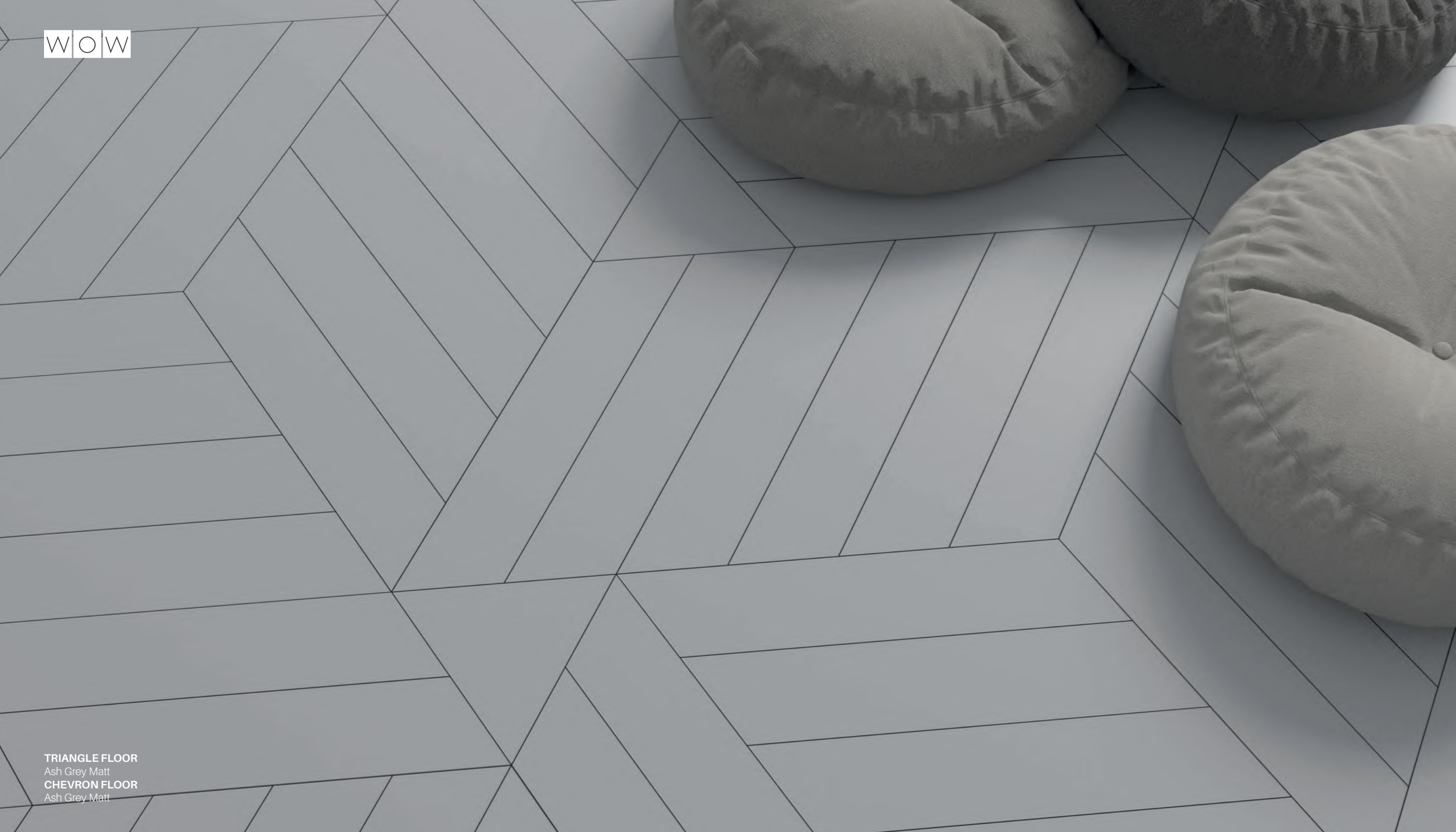

COMPOSITION
composición

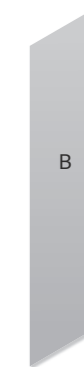

95 %
ASH GREY MATT



ASH GREY MATT
5 %

TRIANGLE FLOOR
Ash Grey Matt
CHEVRON FLOOR
Ash Grey Matt



COMPOSITION
composición



ICE WHITE MATT



CHEVRON FLOOR
Ash Grey Matt

COMPOSITION
composición

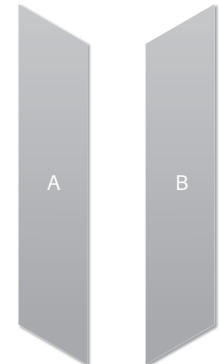

50 % 50 %
ASH GREY MATT

WALL TILE
composición



MOON L by WOW
ICE WHITE MATT
35 %



MOON by WOW
ICE WHITE MATT
65 %

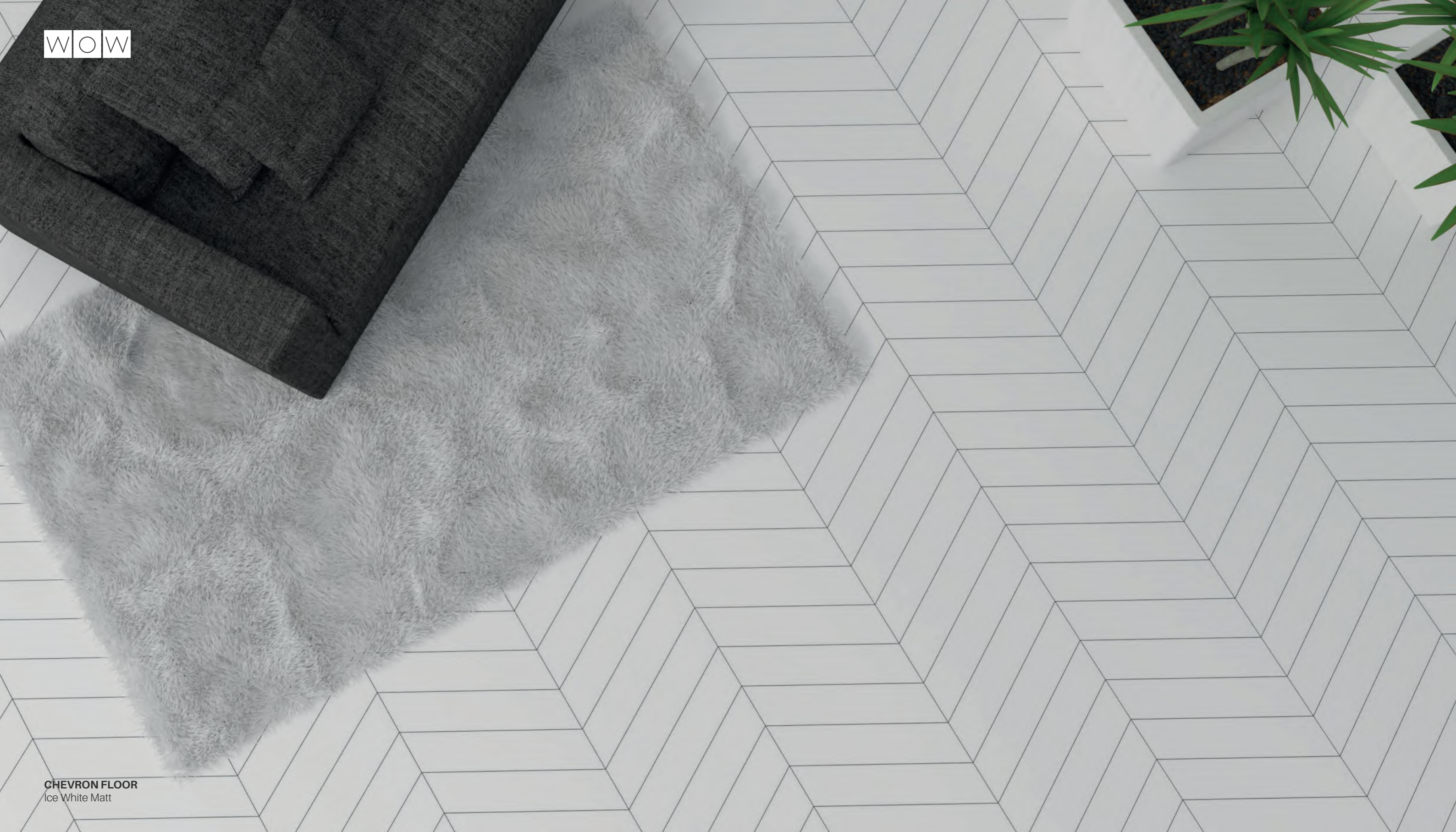

COMPOSITION
composición

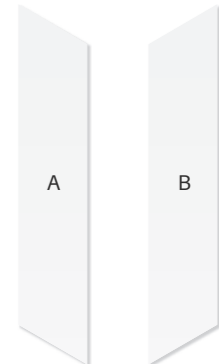

50% 50%
ICE WHITE MATT

CHEVRON FLOOR
Ice White Matt



COMPOSITION
composición

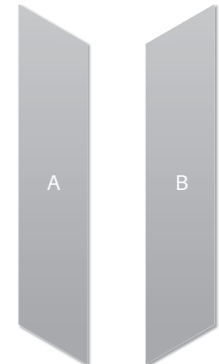



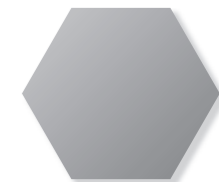





50 % 50 %
ASH GREY MATT



ASH GREY MATT

CHEVRON FLOOR
Ash Grey Matt
HEXA FLOOR
Ash Grey Matt

FLOOR TILES, TECHNICAL FEATURES / INFORMACIÓN TÉCNICA

TECHNICAL FEATURES FOR DRY-PRESSED CERAMIC TILES WITH WATER ABSORPTION B Ia ($\leq 0,5\%$) CARACTERÍSTICAS TÉCNICAS PARA LAS BALDOSAS CERÁMICAS PRENSADAS EN SECO CON ABSORCIÓN DE AGUA B Ia ($\leq 0,5\%$)			
FEATURES / CARACTERÍSTICAS	SPECIFICATION / ESPECIFICACIÓN		NORMA
	Dimensional Features.	Triangle Floor (W 200 +/- 0,6% x 230 +/- 0,6% x h. 8,5 +/- 0,6% mm) GL Hexa Floor (W 200 +/- 0,6% x 230 +/- 0,6% x h. 8,5 +/- 0,6% mm) GL Trapezium Floor (W 98 +/- 0,6% x 227 +/- 0,6% x h. 8,5 +/- 0,6% mm) GL Chevron Floor (W 98 +/- 0,6% x 522 +/- 0,6% x h. 8,5 +/- 0,6% mm) GL	UNE-EN ISO 10545-2:1998
	Water absorption.	$\leq 0,5\%$	UNE-EN ISO 10545-3:1997
	Modulus of rupture and breaking strength.	Minimum 35 N/mm ² Individual Minimum 32 N/mm ²	UNE-EN ISO 10545-4:2012
	Crazing resistance.	Pass	UNE-EN ISO 10545-11:1997
	Household products resistance.	GA	UNE-EN ISO 10545-13:1998
	Chemical resistance.	GLA	UNE-EN ISO 10545-13:1998
	Stain resistance.	>3	UNE-EN ISO 10545-14:1998
	Frost resistance.	Pass	UNE-EN ISO 10545-12:1997
	Non-slip value.	R9 / CLASS 2 DCOF 0,60	DIN 51130:2014 ANSI A137.1:2012

FLOOR TILES, RECOMMENDATIONS / RECOMENDACIONES

WAREHOUSING

In order to guarantee the characteristics of the finish the product must be kept in its original packaging until the time of fixing. If the product is likely to be stored for a long period of time it should be suitably covered.

TILE FIXING

To ensure porcelain earthenware floor tiles adhere correctly to the surface, it is essential to use specific adhesive and grouting material. This must also be suitable for the environment they will have to withstand. Fitting with traditional mortars does not ensure good adhesion.

All types of joints must be planned and carried out correctly: structural, perimeter, expansion and installation joints. Fitting tiles without joints is not advisable from any technical point of view as this may lead to various problems. We recommend a minimum installation joint of 2 mm (0 5/64 in).

MAINTENANCE AND CLEANING

Once the materials have been fitted, it is advisable to remove any remaining adhesive and grouting material by using a commercial descaling product designed especially for ceramic floor tiles, diluted with water. The descaling product must not remain in contact with the surface to be cleaned for more than 5 minutes. To check that the chosen cleaning product will not damage the paving, we recommend previously testing an area that is hidden or not easily seen, or testing a tile that has not been fitted.

As a general guideline, powder detergents should not be used, not wire wool or abrasive materials. Generally a sponge will be sufficient with warm water and liquid neutral soap. Then rinse with plenty of clean water.

ALMACENAMIENTO

Para garantizar las características de su acabado, el producto debe mantenerse en su embalaje original hasta el momento de la colocación. Si el producto va a permanecer almacenado durante un largo periodo es conveniente hacerlo bajo cubierta.

COLOCACIÓN

Para garantizar una buena adhesión al soporte es necesaria la utilización de materiales de agarre y de rejuntado para baldosas de gres porcelánico y adecuados al ambiente al que vayan a estar sometidos. La colocación con morteros tradicionales no garantiza una buena adhesión.

Deberán planificarse y ejecutarse correctamente todo tipo de juntas: estructurales, perimetrales, de dilatación y de colocación. La colocación sin juntas es desaconsejable desde cualquier punto de vista técnico, pudiendo ser el origen de diversas patologías. Se recomienda una junta de colocación de 2 mm.

MANTENIMIENTO Y LIMPIEZA

Finalizada la puesta en obra se recomienda eliminar los restos de materiales de agarre y rejuntado con un desincrustante comercial diseñado expresamente para baldosas cerámicas, rebajado con agua, permaneciendo en contacto con la superficie a limpiar no más de 5 minutos. Para verificar que el limpiador escogido no dañará al pavimento se requiere hacer una prueba previa en una zona oculta o poco visible o en una baldosa sin instalar.

Como norma general no deben utilizarse detergentes en polvo ni estropajos metálicos o abrasivos. Generalmente será suficiente con una esponja, agua tibia y un jabón líquido neutro. Posteriormente aclarar con abundante agua limpia.

FLOOR TILES, DIMENSIONAL FEATURES / PLANIMETRÍA

Hexa Floor

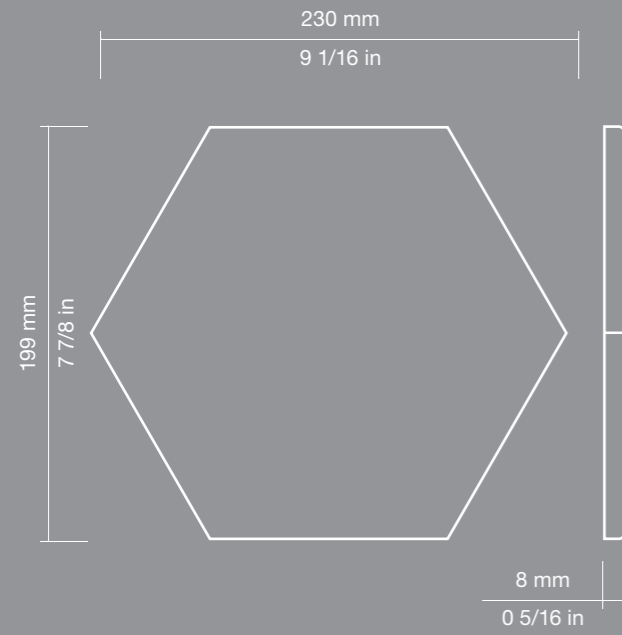

Triangle Floor

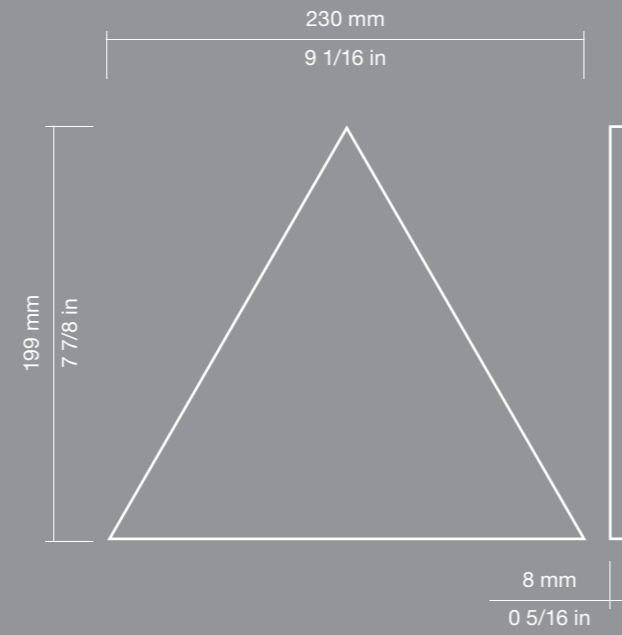

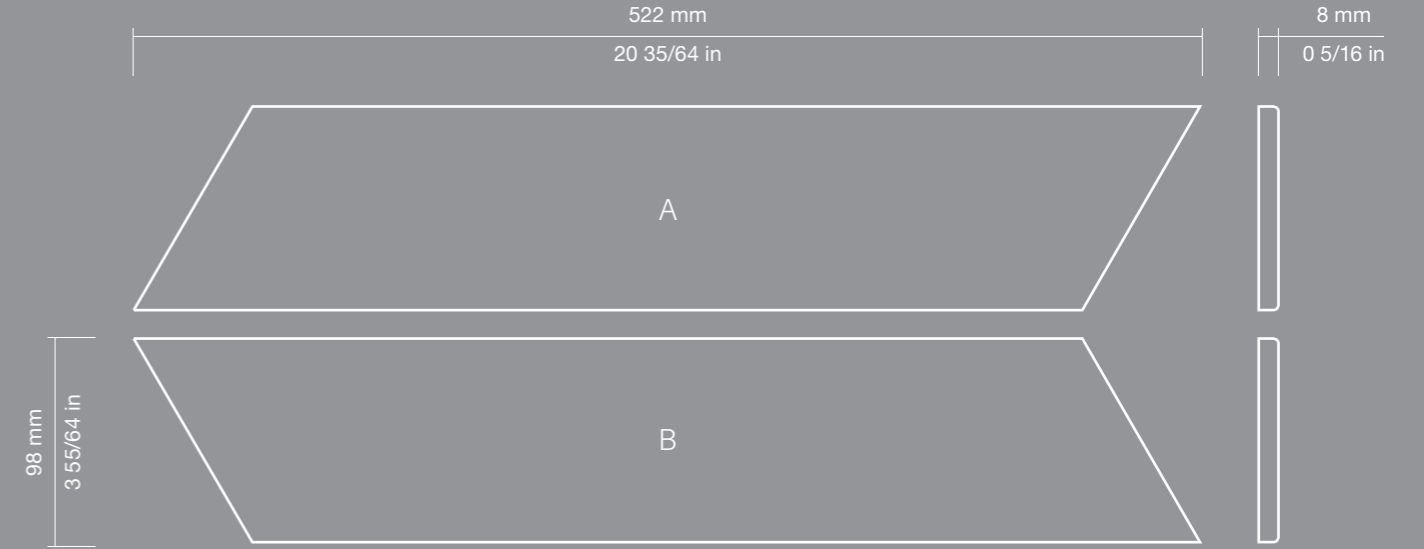

Chevron Floor

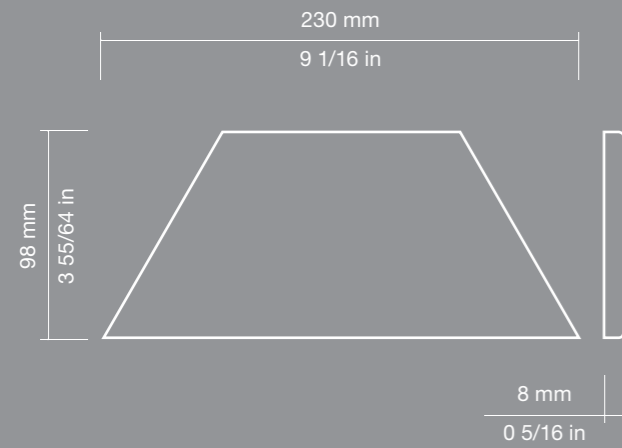

Trapezium Floor



PACKING / ENCAJADO

Modelo / Formato Model / Format	Piezas / Caja Pieces / Box	M2  FT2		KG  LB		Cajas / Palet Boxes / Pallet	M2  FT2	
		m2 / Caja	sq ft / Box	Kg / Caja	Lb/ box		m2 / Palet	sq ft / Pallet
TRIANGLE FLOOR	10	0,233 m2	2,508 sq ft	4,667 kg	10,289 lb	120	27,960 m2	300,960 sq ft
HEXA FLOOR	10	0,349 m2	3,757 sq ft	6,972 kg	15,371 lb	120	41,880 m2	450,840 sq ft
TRAPEZIUM FLOOR	20	0,334 m2	3,595 sq ft	6,932 kg	15,282 lb	120	40,080 m2	431,400 sq ft
CHEVRON FLOOR	10	0,456 m2	4,908 sq ft	8,640 kg	19,048 lb	112	51,072 m2	549,696 sq ft



©2014 Tendencias Cerámicas
WOW, registered trademark of Tendencias Cerámicas, S.L.

The brand use or reproduction of the contents of this catalog, is protected by copyright law. Any use of the brand or reproduction thereof, in part or total, must be authorized by Tendencias Cerámicas, S.L. Otherwise, this action can be sanctioned according to the Law.

©2014 Tendencias Cerámicas
WOW, marca registrada por Tendencias Cerámicas, S.L.

La utilización de la marca o la reproducción del contenido de este catálogo está protegida por la Ley de Propiedad Intelectual. Cualquier uso de la marca o la reproducción del mismo, en parte o en su totalidad, debe ser autorizada por Tendencias Cerámicas, S.L., pudiendo, en caso contrario, ser esta acción sancionada de acuerdo con la Ley.

WOW reserves the right to modify and/or discontinue certain models displayed in this catalogue.
The colour of the pieces displayed herein may differ slightly from originals.
The settings shown in this catalogue are design proposals for advertising purposes.
In real situations in wich the pieces are laid, the installation instructions published by WOW should be followed.

WOW se reserva el derecho de modificar y/o suprimir ciertos modelos expuestos en este catálogo sin previo aviso.
Los colores de las piezas pueden presentar ligeras diferencias respecto a las originales.
Los ambientes que se muestran en este catálogo son sugerencias decorativas de carácter publicitario,
debiéndose utilizar en la instalación real las instrucciones de colocación editadas por WOW.



Polígono Pont, Avda. de España 114
12180 Cabanes,
Castellón (Spain)
t. +34 964 331 910 / f. +34 964 331 911

wowdesigneu.com

info@wowdesigneu.com
comercial@wowdesigneu.com



Designed by

