

MADE IN ITALY. MADE TO EXCEL.

EXENCE



atlas concorde

February 2020



WOOD LOOK
EXENCE
Porcelain tiles

Index

Overview



Spaces



Product Range

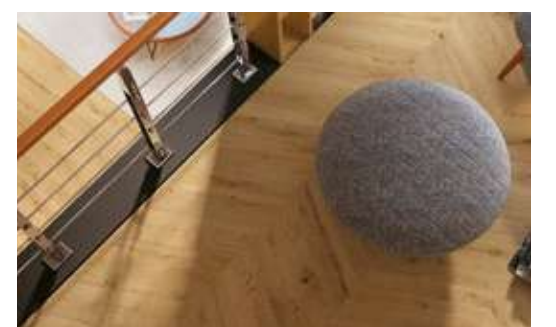

Technical Specifications





● **IT DOES NOT BURN**
Non brucia

● **RECYCLABLE**
Riciclabile

● **HYGIENIC**
Igienico

● **VERSATILE**
Versatile

● **IT LOVES THE ENVIRONMENT**
Ama l'ambiente

● **LONG LASTING**
Dura a lungo

● **SAFE**
Sicuro

● **RESISTANT**
Resistente

● **ZERO PVC**
Zero PVC

● **ZERO VOCS**
Zero VOC

Ceramic and porcelain tiles: the safe choice

Thanks to their extraordinary technical characteristics, porcelain tiles offer exceptional advantages in terms of healthiness, ease of application and use, cleaning, maintenance, and environmental sustainability, making them the safest solution for floors, walls, and surfaces of residential, commercial and public architecture, both indoors and out.

Grazie alle sue straordinarie caratteristiche tecniche, il gres porcellanato offre vantaggi eccezionali in termini di salubrità, facilità di applicazione e utilizzo, pulizia, manutenzione e sostenibilità ambientale, ponendosi come la soluzione più sicura per pavimenti, pareti e superfici dell'architettura residenziale, commerciale e pubblica, in interni ed esterni.

Dank seiner außerordentlichen technischen Eigenschaften bietet das Feinsteinzeug außerordentliche Vorteile in Bezug auf Gesundheitsverträglichkeit, Verlegungs- und Nutzungsfreundlichkeit, Wartung und Umwelt Nachhaltigkeit und wird somit zur sichersten Lösung für Fußböden, Wände und Oberflächen in Innen- und Außenbereichen von privaten, gewerblichen und öffentlichen Architekturen.

Grâce à ses extraordinaires caractéristiques techniques, le grès cérame offre des avantages exceptionnels en termes de salubrité, de facilité d'application, d'utilisation, de nettoyage, d'entretien et de durabilité environnementale, et se présente ainsi comme la solution la plus sûre pour les sols, les murs et les surfaces des constructions résidentielles, commerciales et publiques, en intérieur et en extérieur.

Gracias a sus extraordinarias características técnicas, el gres porcelánico ofrece ventajas excepcionales en términos de sanidad, facilidad de aplicación y uso, limpieza, mantenimiento y sostenibilidad medioambiental, convirtiéndose en la solución más segura para pavimentos, paredes y superficie de la arquitectura residencial, comercial y pública, tanto en interiores como en exteriores.

Благодаря своим превосходным техническим характеристикам керамогранит обладает такими достоинствами, как безопасность для здоровья, простота монтажа, эксплуатации и ухода, экологичность. Вот почему является отличным решением для оформления полов, стен и многих других поверхностей в жилых, коммерческих и общественных архитектурных контекстах, внутри помещений и на улице.

Natural accents

Designed to decorate living spaces with a contemporary look, the Exence collection creates a natural, welcoming, and refined atmosphere for interior designs with a metropolitan inspiration.

Progettata per vestire gli spazi dell'abitare con un'estetica contemporanea, la collezione Exence crea un'atmosfera naturale, accogliente e ricercata, dedicata a progetti di interni d'ispirazione metropolitana.

Die zur zeitgemäßen Kleidung unserer Wohnräume konzipierte Kollektion Exence erzeugt eine natürliche, einladende und stilvolle Atmosphäre. Für am Großstadtchic inspirierte Projekte.

Conçue pour revêtir les espaces de l'habitat avec un esthétisme contemporain, la collection Exence crée une atmosphère naturelle, accueillante et raffinée, et est dédiée aux projets d'intérieur d'inspiration urbaine.

La nueva colección de superficies Exence dedicada a proyectos interioristas de inspiración metropolitana, plasma la propia naturaleza estética vistiendo los espacios de las viviendas con las últimas tendencias de diseño y glamur vanguardista, generando atmósferas naturales y acogedoras.

Современная по дизайну коллекция Exence задумана для стильного оформления жилых интерьеров в урбанистическом стиле и создания в них натуральной, уютной, изысканной атмосферы.



A fascination with wood

Exence features the natural look of Italian oak, strictly faithful to the colors and shades of the original material. The Saw Cut look brings out the earthiness and aged appearance of wood marked by the passage of the saw blade.

Exence vede protagonista l'effetto rovere italiano, in versione naturale, estremamente rigoroso e fedele alle cromie e alle sfumature dell'essenza originale; Saw Cut, capace di esprimere forte matericità e restituire l'aspetto vissuto del legno con i segni irregolari lasciati dalla lavorazione, "taglio sega".

Im Mittelpunkt von Exence steht die italienische Eiche in ihrer ganzen Natürlichkeit, deren originale Farben und Nuancen extrem detailgetreu nachempfunden sind. Die Ausführung Saw Cut bringt mit dem „gelebten“ Aussehen des Holzes und den unregelmäßigen Spuren der Sägearbeitung die Besonderheit des Materials perfekt und intensiv zum Ausdruck.

Le protagoniste d'Exence est l'effet chêne italien, en version naturelle, extrêmement rigoureux et fidèle aux teintes et aux nuances de l'essence originale, tandis que Saw Cut, capable de traduire la puissance de la matière, offre l'aspect usé du bois avec les signes irréguliers laissés par l'usinage en "dents de scie".

Con la serie Exence cobra protagonismo la imitación mader roble italiana, en la versión natural, extremadamente rigurosa y fiel a las cromías y gradaciones de la materia original; Saw Cut, expresa una fuerte matericidad y elegancia restituyendo de forma realista el aspecto desgastado de la madera con las irregularidades dejadas por la elaboración "corte de sierra".

Exence предлагает рисунок натуральной древесины итальянского дуба, который с невероятной точностью передает все цвета и оттенки исходного природного материала. Поверхность Saw Cut имеет выраженную фактурность и приятный состаренный вид с неровностями, оставленными распилом.





Contemporary elegance



Strong aesthetic appeal of the wood effect. Simple look. Warm shades inspired by the essence of oak. These are some of the traits that distinguish the Exence collection, which will create contemporary environments that recall the traditions of another time without sacrificing elegance.

Forte appeal estetico dell'effetto legno. Look essenziale. Tonalità calde ispirate all'essenza del rovere. Sono questi alcuni tratti di stile che caratterizzano la collezione Exence, da cui nascono ambienti contemporanei all'insegna della tradizione, senza rinunciare ad eleganti suggestioni.

Die ganze Anziehungskraft der Holzoptik. Ein auf das Wesentliche beschränkter Look. Die warmen Farbtöne der Eiche. Das sind einige der Stilmerkmale, die die Kollektion Exence auszeichnen. Sie lässt zeitgemäße Räume entstehen, die in der Tradition verwurzelt sind, aber nicht auf elegante Akzente verzichten.

Grand charme esthétique de l'effet bois. Look minimaliste. Tonalités chaudes qui s'inspirent de l'essence du chêne. Ce ne sont que quelques aspects du style distinctif qui caractérisent la collection Exence, qui permet de créer des espaces contemporains sous le signe de la tradition, sans renoncer aux suggestions élégantes.

Destila la belleza estética del efecto madera. Look minimalista. Tonicaciones cálidas inspiradas en la esencia de la madera roble. Estos son algunos de los elementos de estilo que caracterizan la colección Exence, dando vida a ambientes contemporáneos fieles a la tradición sin renunciar a la elegancia, diseño y funcionalidad.

Неотразимая привлекательность рисунка дерева. Благородно простой вид. Теплые тона дуба. Именно эти особенности коллекции Exence помогают создать стильные современные интерьеры, в которых ощущается приятное звучание традиций и изысканная элегантная нота.



Exence features surfaces where linear or complex patterns in a soft color palette convey an accent of unmistakable style that matches the character of luminous architectural spaces designed to maximize comfort and hospitality.

Exence dà vita a superfici dove l'equilibrio, tra pattern lineari o più articolati con morbidi cromatismi, dona un accento di stile inconfondibile che ben corrisponde al carattere di spazi architettonici luminosi, improntati su concetti di comfort e di accoglienza.

Exence gestaltet Flächen, in denen das ausgewogene Verhältnis zwischen geradlinigen oder komplexeren Mustern und weichen Farben einen unverwechselbaren Stil prägt, der perfekt zu hellen, weiten Bauvolumen passt, in denen Komfort und Behaglichkeit ganz groß geschrieben werden.

Exence donne naissance à des surfaces où l'équilibre, entre des motifs linéaires ou des motifs plus articulés aux chromatismes délicats, confère une touche de style unique qui correspond bien au caractère d'espaces architecturaux lumineux fondés sur des concepts de confort et d'hospitalité.

La colección Exence da vida a superficies en las que el equilibrio, entre pattern lineales o articulados con suaves cromatismos, aporta un toque de glamur inconfundible que se ajustan al carácter de espacios arquitectónicos dinámicos y luminosos, basados en los conceptos de confort y de hospitalidad.

На поверхностях Exence гармонично сплетаются мягкие цвета и натуральные рисунки древесины – то простые, то более сложные. Все это становится стильным акцентом светлых, уютных, гостеприимных архитектурных пространств.

Filled with light



Expressing authenticity ¹⁴

Wellness reloaded ²⁴

Welcoming spaces ³⁴

A pool with a view ⁴²

The versatility of the Exence collection presents solutions inspired by tradition and authenticity. A contemporary elegance that conveys a strong personality in residential interiors, wellness environments, and retail spaces, increasingly considered as drivers of urban regeneration.

La versatilità della collezione Exence presenta soluzioni ispirate alla tradizione e all'autenticità. Un segno di modernità ed eleganza che imprime una forte personalità negli interni domestici, ad ambienti wellness o spazi retail, sempre più considerati driver della rigenerazione urbana.

Aus der Vielseitigkeit der Kollektion Exence entstehen Raumideen im Zeichen der Tradition und Authentizität. Ein Zeichen der Modernität und Eleganz, das Wohnungen, Wellness-Bereichen sowie den für die Revitalisierung der Städte immer wichtigeren Verkaufsräumen eine starke Persönlichkeit verleiht.

L'éclectisme de la collection Exence présente des solutions qui s'inspirent de la tradition et de l'authenticité. Une touche de modernité et d'élégance qui imprime une forte personnalité aux intérieurs domestiques, aux espaces commerciaux ou de bien-être, qui sont de plus en plus considérés comme des boosters de la régénération urbaine.

La versatilidad de la colección Exence presenta soluciones inspiradas en la tradición y la autenticidad. Un elemento representativo de modernidad y elegancia aporta fuertes cualidades al interiorismo doméstico, a estancias dedicadas al bienestar o a espacios comerciales, considerados cada vez más guías de la renovación urbana.

Коллекция Exence идеальна для интерьерных решений, проникнутых традициями и аутентичностью. И в то же время способна придать современной элегантность как домашним помещениям, так коммерческим или велнес-пространствам – ценным источникам восстановления душевных и физических сил в суете городской жизни.



Expressing authenticity

LIVING & DINING

With a texture that faithfully reflects oak's natural qualities, Exence fully expresses the authenticity of the natural wood. Available in the Almond shade, it creates a warm and welcoming atmosphere in harmony with domestic interiors inspired by easy living.

Con una texture che riprende fedelmente le caratteristiche del rovere, Exence esprime appieno l'autenticità dell'essenza naturale. Declinata nella tonalità Almond, crea un'atmosfera calda e accogliente, in armonia con interni domestici ispirati all'easy living.

Die Strukturierung von Exence gibt die Besonderheiten der Eiche detailgetreu wieder und bringt damit die Authentizität der natürlichen Materie voll zum Ausdruck. Der Farbton Almond sorgt für eine warme und behagliche Atmosphäre, die ganz einer im Zeichen des Easy Living stehenden Wohnung entspricht.

Grâce à sa texture qui reprend fidèlement les caractéristiques du chêne, Exence exprime pleinement l'authenticité de l'essence naturelle. Déclinée dans la tonalité Almond, elle crée une ambiance chaude et accueillante, en harmonie avec l'intérieur domestique qui s'inspire de l'easy living.

Con una textura que emula fielmente las características del roble, la colección Exence rescata toda su autenticidad y encanto de la esencia natural. Propuesta en el color Almond, crea una atmósfera cálida y acogedora en armonía con el interiorismo de viviendas inspiradas en "easy living".

Поверхность плиток Exence удивительно точно передает эстетические характеристики натуральной древесины дуба и дарит то же ощущение аутентичности. Цвет Almond рождает в доме теплую, излучающую радость атмосферу.



atlas concorde





atlas concorde



atlas concorde

Included in the collection's selection of decorative pieces, Chevron is a great classic for those wanting a herringbone installation. The design – a contemporary interpretation of traditional vintage floors – makes it possible to produce dynamic, captivating patterns.

Tra le proposte dell'apparato decorativo della collezione, Chevron rappresenta un grande classico della posa a spina di pesce. Con il suo disegno, che reinterpreta in chiave contemporanea quello dei pavimenti d'epoca tradizionale, compone pattern dinamici, che catturano lo sguardo.

Eines der Dekore der Kollektion ist Chevron, ein großer Klassiker des Fischgrätmotivs. Mit seinem Muster, einer zeitgemäßen Neuinterpretation des Motivs traditioneller Bodenbeläge, entstehen dynamische Effekte, die als Blickfang dienen.

Parmi les propositions du système décoratif de la collection, Chevron représente un grand classique de la pose en forme de V. Son dessin réinterprète les sols traditionnels d'époque en clé contemporaine et crée des motifs dynamiques qui capturent le regard.

Entre las propuestas decorativas de la colección, Chevron representa un gran clásico de la colocación en espina de pez. Con su movimiento gráfico que interpreta en clave moderna el pavimento de época tradicional, compone pattern dinámicos que atrapan la mirada.

Декор Chevron, включенный в гамму декоративных элементов коллекции, предназначен для елочной схемы укладки, давно ставшей классикой. Получаемый рисунок пересматривает в современном ключе старые традиционные полы, привлекая взгляд стильным динамизмом.



Beauty is in the details

In the Saw Cut version, Exence boosts the natural character of the wall tile by replicating the uneven effect of traditional cuts made from a blade. The open space of the dining environment is enhanced by the evocative relationship between light and the soft nuances of the Almond color variant.

Nella versione Saw Cut, Exence accentua la naturalità del rivestimento, restituendo l'effetto irregolare della lavorazione tradizionale a "taglio sega". L'open space dell'ambiente dining è valorizzato dal rapporto evocativo tra la luce e le morbide sfumature della variante colore Almond.

In der Version Saw Cut unterstreicht Exence die Natürlichkeit des Wandbelags durch die traditionell anmutende und wie gesägt aussehende unregelmäßige Optik. Der offene Essbereich kommt durch den Dialog zwischen dem Licht und den weichen Nuancen der Farbvariante Almond besonders gut zur Geltung.

La colección Exence en la versión Saw Cut intensifica la naturalidad del revestimiento, restituyendo el efecto irregular de la elaboración tradicional "corte de sierra". El open space del ambiente dining está valorizado por la relación entre la luz y los matices esfumados del color Almond.

Dans la version Saw Cut, Exence accentue l'inspiration naturelle du revêtement qui reproduit l'effet irrégulier de l'usage traditionnel en "dents de scie". L'open space du dining est valorisé par le rapport entre la lumière et les nuances délicates de la teinte Almond.

В варианте поверхности Saw Cut коллекция Exence передает неровности, остающиеся на древесине после распила. Эффект простора в столовой комнате усилен изобилием света и мягкими оттенками цвета Almond.



The Tatami decoration is particularly versatile, suitable for use even on curved surfaces.

Particolarmente versatile nelle sue applicazioni è il decoro Tatami, adatto anche a rivestire le superfici curve.

Das Dekor Tatami, das sich auch zur Verkleidung gekrümmter Flächen eignet, ist ganz besonders vielseitig.

Particulièrement éclectique dans toutes ses applications, le décor Tatami est également adapté pour revêtir des surfaces arrondies.

La decoración Tatami es decididamente versátil en sus aplicaciones, además indicado para vestir las superficies curvas.

Декоративный элемент Tatami необыкновенно функционален и подходит также для покрытия изогнутых поверхностей.



PORCELAIN TILES

LIVING

Exence Almond
Matt 18,5x150 cm | 7 1/4"x59"

Exence Almond
Grip 18,5x150 cm | 7 1/4"x59"

Boost White
Matt 120x278 cm | 47 1/4"x109 1/2"
6 mm

Exence Almond
Chevron 32,5x45 cm | 12 3/4"x17 3/4"

DINING

Exence Almond
Saw Cut 18,5x150 cm | 7 1/4"x59"

Exence Almond
Tatami 18,5x75 cm | 7 1/4"x29 1/2"

AtlasPlan Boost Smoke
Matt 162x324 cm | 63 3/4"x127 1/2"

Wellness reloaded

SPA

Natural wood – which in Nordic tradition defines environments dedicated to taking care of oneself – was the inspiration for wellness spaces promoting harmony of the body and spirit. The Saw Cut version of Exence Amber accentuates the natural character of the effect and the irregularity of the texture.

Dal legno naturale, che nella tradizione nordica definisce gli spazi dedicati alla cura del sé, è nata l'ispirazione per progettare ambienti wellness dove ritrovare l'armonia tra corpo e spirito. La versione Saw Cut di Exence Amber accentua la naturalità dell'effetto con l'irregolarità della texture.

Vom Naturholz, das in der Tradition des Nordens von jeher Räume wie Saunas und Bäder kleidet, stammt die Inspiration für Wellness-Räume, in denen wir die Harmonie zwischen Körper und Geist wiederfinden. Die Version Saw Cut von Exence Amber akzentuiert die natürliche Wirkung durch ihre unregelmäßige Struktur.

C'est à partir du bois naturel, qui dans la tradition nordique définit les espaces dédiés au bien-être, qu'est née l'inspiration pour concevoir des espaces où retrouver l'harmonie entre le corps et l'esprit. La version Saw Cut d'Exence Amber accentue le naturel de l'effet avec l'irrégularité de la texture.

En la tradición nórdica los espacios dedicados al cuidado del cuerpo están diseñados a partir de la madera natural, materia inspiradora de proyectos que confieren pureza y autenticidad a estancias dedicadas al bienestar, portadoras de armonía entre el cuerpo y el espíritu. La versión Saw Cut de Exence Amber intensifica la naturaleza del efecto con las irregularidades de la textura.

Традиционно в скандинавских странах основным материалом для отделки помещений, отведенных для ухода за собой, является натуральное дерево. Его имитацию мы использовали в оформлении современного велнес-пространства, помогающего приятно восстановить гармонию души и тела. Поверхность Saw Cut цвета Amber подчеркивает натуральность рисунка естественной неровностью фактуры.

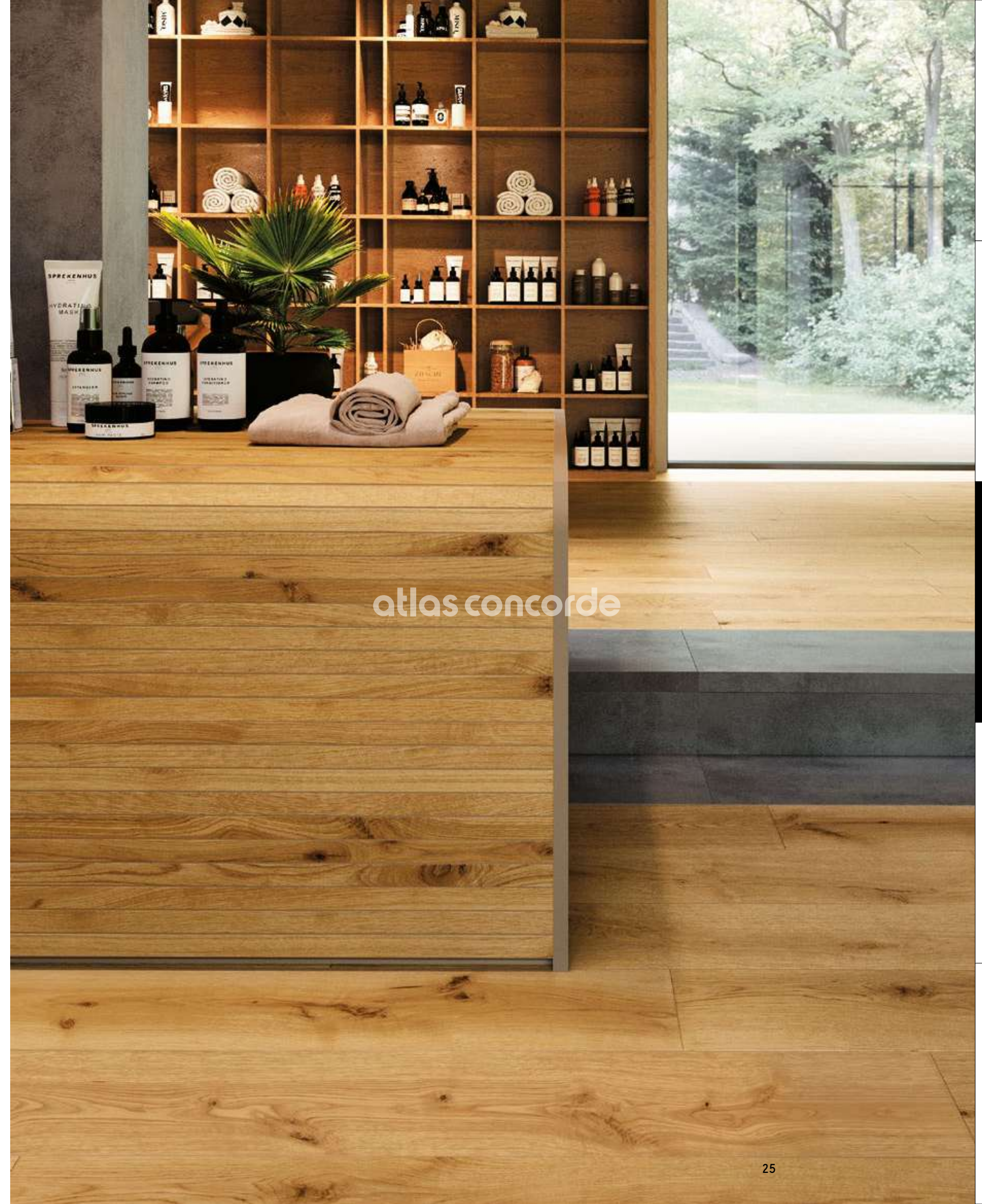

atlas concorde



atlasconcorde



PORCELAIN TILES

ENTRANCE

Exence Amber
Saw Cut 18,5x150 cm | 7 1/4"x59"

Boost Smoke
Matt 120x278 cm | 47 1/4"x109 1/2"
6 mm

AtlasPlan Boost Smoke
Matt 162x324 cm | 63 3/4"x127 1/2"

SPA

Exence Amber
Grip 18,5x150 cm | 7 1/4"x59"

Exence Amber
Tatami 18,5x75 cm | 7 1/4"x29 1/2"

Exence Amber
Square 56,1x56,1 cm | 22"x22"

SPA

Boost Smoke
Matt 120x278 cm | 47 1/4"x109 1/2"
6 mm



atlas concorde

Textured effects

The warm tones of the Amber shade create a relaxing and welcoming ambiance in the spa area, defined by a simple design. The non-slip finish was specifically designed for wet environments.

I toni caldi della variante cromatica Amber creano un'atmosfera rilassante e accogliente nell'area spa, definita da un design essenziale. La finitura grip antiscivolo è stata studiata appositamente per gli ambienti umidi.

Die warmen Nuancen der Farbvariante Amber erzeugen eine entspannte, behagliche Atmosphäre in dem von schlichtem Design geprägten Spa-Bereich. Die rutschfeste Oberfläche wurde eigens für feuchte Bereiche entwickelt.

Las zonas spa están definidas por un diseño de estética minimalista gracias a los tonos cálidos de la variante cromática Amber, generando atmósferas relajantes y acogedoras. La rugosidad del acabado grip de alta resistencia al deslizamiento se ha estudiado expresamente para las zonas húmedas.

Les tons chauds de la variante chromatique Amber créent une atmosphère accueillante et relaxante dans le spa qui est défini par un design minimaliste. La finition antiglisse a été spécialement étudiée pour les lieux humides.

Теплые тона цвета Amber рождают в лаконичном по дизайну СПА-интерьере релаксирующую атмосферу. Противоскользящая поверхность Grip разработана специально для влажных пространств.



One of the interesting decorations in the Exence collection is Square, designed as a tangram composed of unconventional geometric shapes that play with broken lines. An ideal solution to add movement to the surface and the interior design.

Una variante interessante di decoro della collezione Exence è Square, disegnato come un tangram composto da figure geometriche non convenzionali che giocano con linee spezzate. Una soluzione ideale per dare movimento alla superficie e agli interni.

Eine besonders interessante Dekoridee der Kollektion Exence ist Square. Es wirkt wie ein Tangram aus ungewohnten geometrischen Figuren, die mit durchbrochenen Linien spielen. Eine ideale Lösung, um Flächen und Innenräumen Bewegung zu verleihen.

Une variante intéressante du décor de la collection Exence est Square, dessiné comme un tangram composé de figures géométriques non conventionnelles qui jouent avec des lignes brisées. Une solution idéale pour donner du mouvement à la surface et aux intérieurs.

La colección Exence incorpora una variante sugestiva de decoración; es Square, diseñada como un tangram compuesto por figuras geométricas no convencionales que juegan con líneas partidas. Una solución indicada para aportar dinamismo sorprendente a la superficie y a los interiores.

Интересным вариантом декоративного элемента коллекции Exence является Square. Он подобен танграму, чьи геометрические фигуры рожают оригинальный рисунок из ломаных линий. Идеальное решение для придания поверхностям и интерьерам выразительного динамизма.

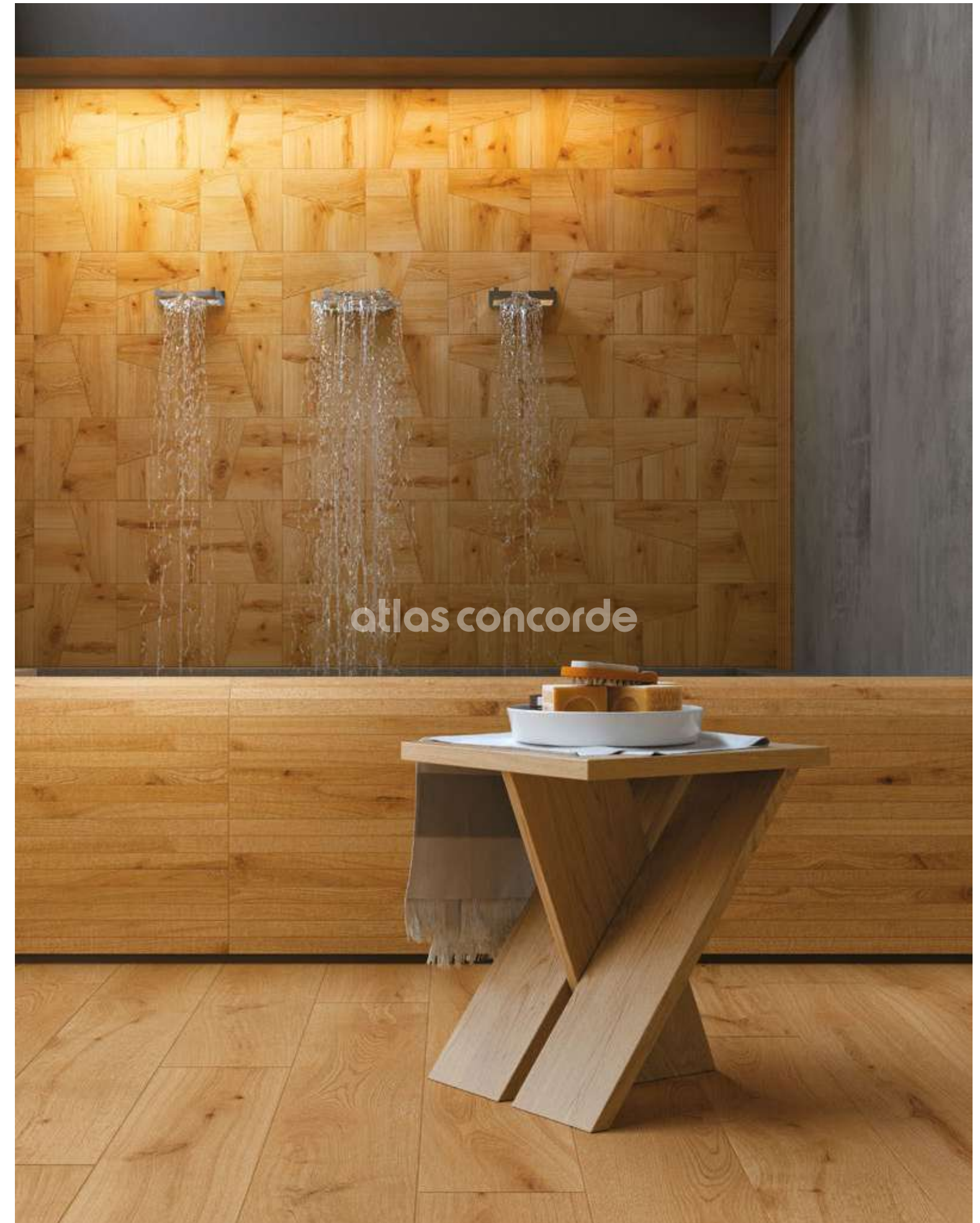

Welcoming spaces

SHOWROOM

The look of oak creates a friendly and comfortable atmosphere in new commercial spaces. Thanks to its elegance and authenticity, the Exence collection also adds a domestic dimension to spaces dedicated to the community.

L'estetica dei roveri crea un'atmosfera amichevole e confortevole nei nuovi spazi commerciali. Grazie alla sua eleganza ed autenticità, la collezione Exence conferisce una dimensione domestica anche ai luoghi dedicati alla collettività.

Die Eichenoptik erzeugt in modernen, gewerblich genutzten Räumen eine freundliche und angenehme Atmosphäre. Mit ihrer Eleganz und Authentizität verleiht die Kollektion Exence auch Orten des öffentlichen Lebens eine häusliche Dimension.

L'esthétisme des essences de chêne crée une atmosphère conviviale et confortable dans les nouveaux espaces commerciaux. Grâce à son élégance et à son authenticité, la collection Exence confère une dimension domestique même aux lieux dédiés à la collectivité.

La estética de los robles generan atmósferas encantadoras y confortables en los nuevos espacios comerciales. Gracias a su elegancia y autenticidad, la colección Exence otorga un matiz doméstico a los lugares dedicados a la colectividad.

Рисунок древесины дуба создает в коммерческих пространствах комфортную неформальную обстановку. Благодаря естественной элегантности коллекции Exence даже общественные интерьеры приобретают домашнюю теплоту.



atlas concorde



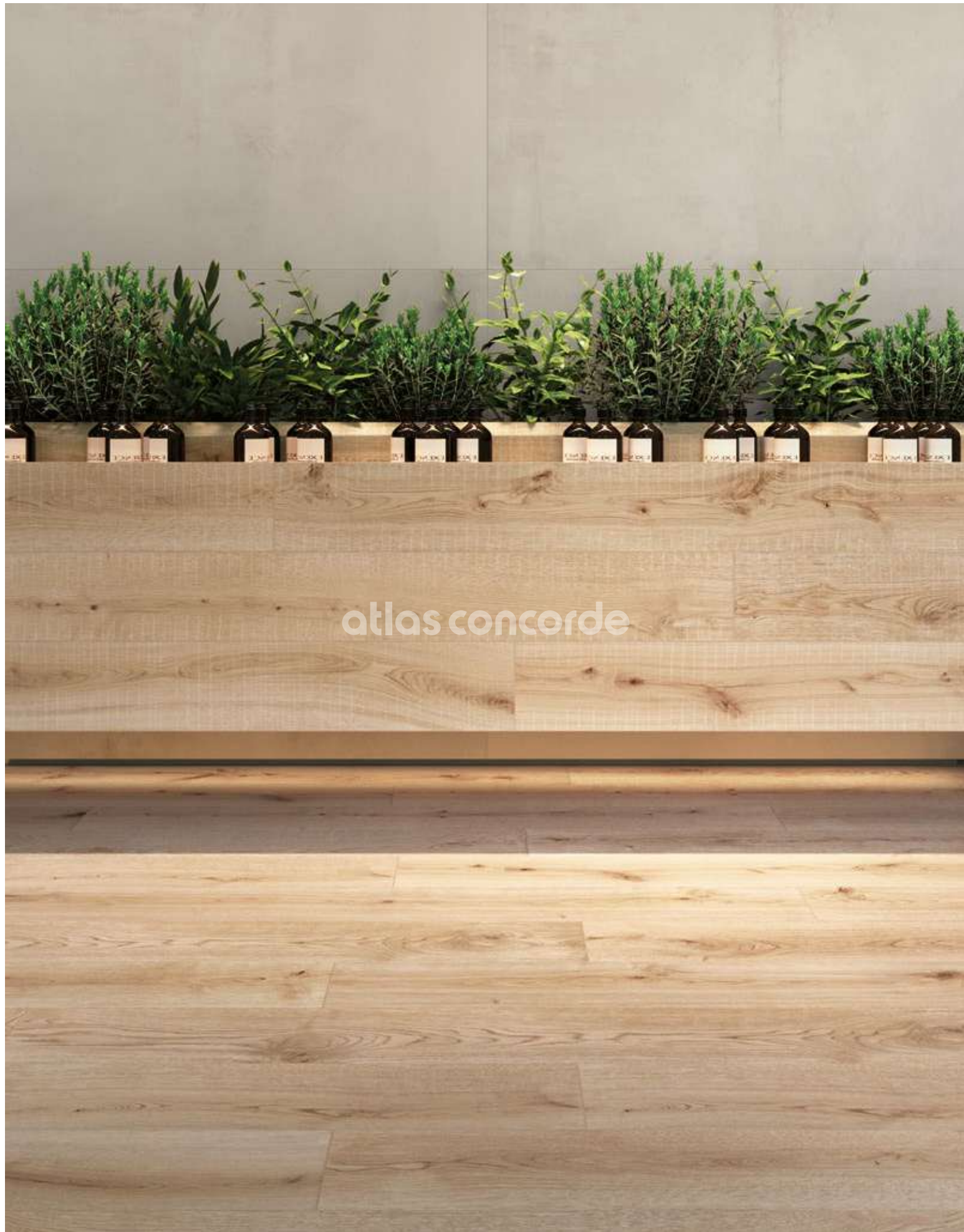

atlas concorde



atlas concorde

PORCELAIN TILES

SHOWROOM

Exence Vanilla
Matt 18,5x150 cm | 7 1/4" x 59"

Boost White
Matt 120x278 cm | 47 1/4" x 109 1/2"
6 mm

RELAX AREA

Exence Vanilla
Saw Cut 18,5x150 cm | 7 1/4" x 59"

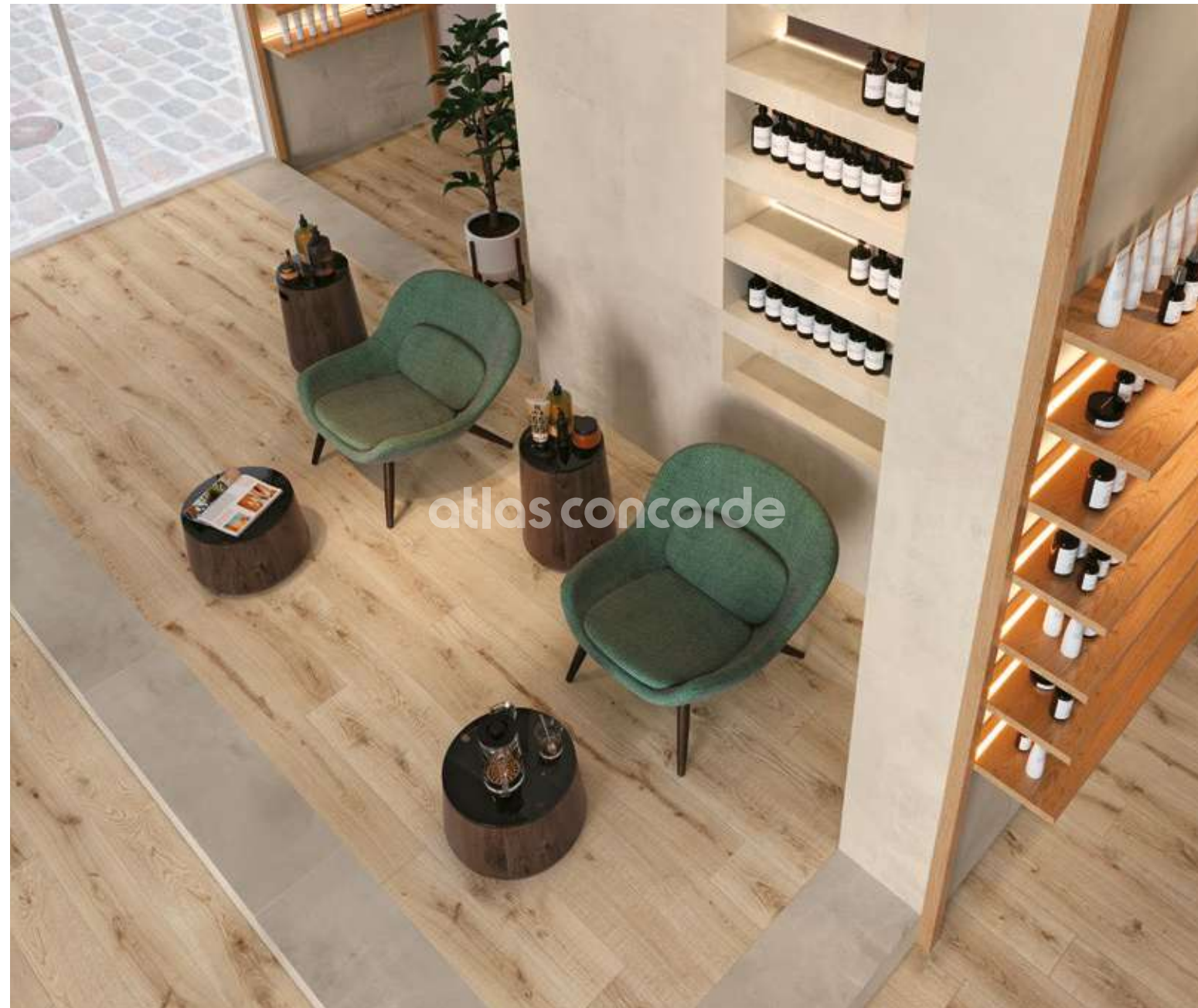

STYLISH SIMPLICITY

With its irregular grooves typical of the saw cuts, Exence Vanilla Saw Cut adds character and personality to interiors. Perfect for showrooms distinguished by formal simplicity and a clean look.

Con le sue scanalature irregolari, tipiche della lavorazione "taglio sega", Exence Vanilla Saw Cut aggiunge carattere e personalità agli interni. Perfetto per connotare showroom improntati alla semplicità formale e a un design essenziale.

Mit seinen für die „Sägeschnitt-Optik“ typischen, unregelmäßigen Rillen bringt Exence Vanilla Saw Cut Charakter und Persönlichkeit in den Raum. Einfach perfekt für die Gestaltung von Showrooms, die von formaler Schlichtheit und einem klaren Design geprägt sind.

Avec ses stries irrégulières, typiques de l'usinage en "dents de scie", Exence Vanilla Saw Cut donne du caractère et une forte personnalité à tous les intérieurs. Une surface parfaite pour caractériser les showrooms qui, à la simplicité des formes, veulent allier un design minimaliste.

Con el veteado irregular y refinado típico de la elaboración "corte de sierra", la colección Exence Vanilla Saw Cut añade carácter y personalidad a las estancias. Indicada para definir salas de exposición que conllevan la simplicidad y encanto y en un diseño minimalista.

Своими неравномерными, характерными для пиленной древесины бороздками Exence Vanilla Saw Cut придает интерьеру пленительную индивидуальность. Коллекция идеальна для шоу-румов, в которых доминирует простота форм и лаконичный дизайн.



A pool with a view

OUTDOOR



PORCELAIN TILES

OUTDOOR

Exence Almond
Matt 30x120 cm | 11 3/4"x47 1/4" ± 20 mm

Exence Almond Round
Matt 30x120 cm | 11 3/4"x47 1/4" ± 20 mm

Exence Almond Round Ang. Dx/Sx
Matt 30x120 cm | 11 3/4"x47 1/4" ± 20 mm

Exence Almond Alzata
Matt 30x120 cm | 11 3/4"x47 1/4" ± 20 mm

Boost Grey
Matt 120x120 cm | 47 1/4"x47 1/4" 6 mm



EXENCE

Porcelain tiles

COLOURED BODY PORCELAIN TILES - RECTIFIED MONOCALIBER

GRES PORCELLANATO COLORATO IN MASSA - RETTIFICATO MONOCALIBRO

Gres porcelánico coloreado en masa - Rectificado monocalibre / Durchgefärbtes Feinsteinzeug - Geschliffen einkalibrig

Grès cérame coloré dans la masse - Rectifié mono-calibre / Керамический гранит окрашенный в массе - Ретифицированный в одном калибре

MATTE / MATT

MATE / MATT / MAT / МАТОВАЯ

18,5x150 cm - 7 1/4"x59"

± 9 mm



V2 SLIGHT VARIATION

Exence Vanilla
18,5x150 cm / 7 1/4"x59"



Exence Almond
18,5x150 cm / 7 1/4"x59"



Exence Amber
18,5x150 cm / 7 1/4"x59"



Exence Vanilla Saw Cut
18,5x150 cm / 7 1/4"x59"



Exence Almond Saw Cut
18,5x150 cm / 7 1/4"x59"



Exence Amber Saw Cut
18,5x150 cm / 7 1/4"x59"



EXENCE

Porcelain tiles

COLOURED BODY PORCELAIN TILES - RECTIFIED MONOCALIBER

GRES PORCELLANATO COLORATO IN MASSA - RETTIFICATO MONOCALIBRO

Gres porcelánico coloreado en masa - Rectificado monocalibre / Durchgefärbtes Feinsteinzeug - Geschliffen einkalibrig

Grès cérame coloré dans la masse - Rectifié mono-calibre / Керамический гранит окрашенный в массе - Ретифицированный в одном калибре

GRIP / GRIP
GRIP / GRIP / GRIP / GRIP

18,5x150 cm - 7¹/₄"x59"

± 9 mm



MATTE / MATT
MATE / MATT / MAT / MATOBAЯ

20x120 cm - 7⁷/₈"x47¹/₄"

± 9 mm



Exence Vanilla
18,5x150 cm / 7¹/₄"x59"



Exence Almond
18,5x150 cm / 7¹/₄"x59"



Exence Amber
18,5x150 cm / 7¹/₄"x59"



Exence Vanilla
20x120 cm / 7⁷/₈"x47¹/₄"



Exence Almond
20x120 cm / 7⁷/₈"x47¹/₄"



Exence Amber
20x120 cm / 7⁷/₈"x47¹/₄"



EXENCE

Porcelain tiles

COLOURED BODY PORCELAIN TILES - RECTIFIED MONOCALIBER

GRES PORCELLANATO COLORATO IN MASSA - RETTIFICATO MONOCALIBRO

Gres porcelánico coloreado en masa - Rectificado monocalibre / Durchgefärbtes Feinsteinzeug - Geschliffen einkalibrig

Grès cérame coloré dans la masse - Rectifié mono-calibre / Керамический гранит окрашенный в массе - Ретифицированный в одном калибре

OUTDOOR PAVING ±20 mm / PAVIMENTI DA ESTERNO ±20 mm

REVÊTEMENTS DE SOL EXTÉRIEURS ±20 mm / BÖDEN IM AUSSENBEREICH ±20 mm

PAVIMENTOS EXTERNOS ±20 mm / НАРУЖНЫЕ НАПОЛЬНЫЕ ПОКРЫТИЯ ±20 mm

30x120 cm - 12"x47 1/4"

± 20 mm



V2 SLIGHT VARIATION

Exence Almond

30x120 cm / 12"x47 1/4"



Exence Amber

30x120 cm / 12"x47 1/4"



Porcelain tiles ± 20 mm

For further details on the 20mm thick products, related trim pieces and installation systems - in particular for recommendations and precautions during installation- please refer to the Outdoor Design section on the Atlas Concorde website or to the Outdoor Design catalogue. / Per dettagli sul prodotto e sui relativi pezzi speciali in 20mm di spessore, per i sistemi di posa e, in particolare, per raccomandazioni, accorgimenti e precauzioni in fase di posa e progettazione, si raccomanda di prendere visione del catalogo Outdoor Design e della sezione Outdoor Design del sito Atlas Concorde.

EXENCE

Porcelain Tile Decors

COLOURED BODY PORCELAIN TILES - RECTIFIED MONOCALIBER

GRES PORCELLANATO COLORATO IN MASSA - RETTIFICATO MONOCALIBRO

Gres porcelánico coloreado en masa - Rectificado monocalibre / Durchgefärbtes Feinsteinzeug - Geschliffen einkalibrig

Grès cérame coloré dans la masse - Rectifié mono-calibre / Керамический гранит окрашенный в массе - Ретифицированный в одном калибре

Exence Vanilla Square

56,1x56,1 cm / 22"x22"



Exence Almond Square

56,1x56,1 cm / 22"x22"



Exence Amber Square

56,1x56,1 cm / 22"x22"



Exence Vanilla Tatami

18,5x75 cm / 7 1/4"x29 1/2"



Exence Almond Tatami

18,5x75 cm / 7 1/4"x29 1/2"



Exence Amber Tatami

18,5x75 cm / 7 1/4"x29 1/2"



Exence Vanilla Chevron

32,5x45 cm / 12 3/4"x17 3/4"



Exence Almond Chevron

32,5x45 cm / 12 3/4"x17 3/4"



Exence Amber Chevron

32,5x45 cm / 12 3/4"x17 3/4"



EXENCE

Porcelain Trim tiles

INDOOR TRIM TILES

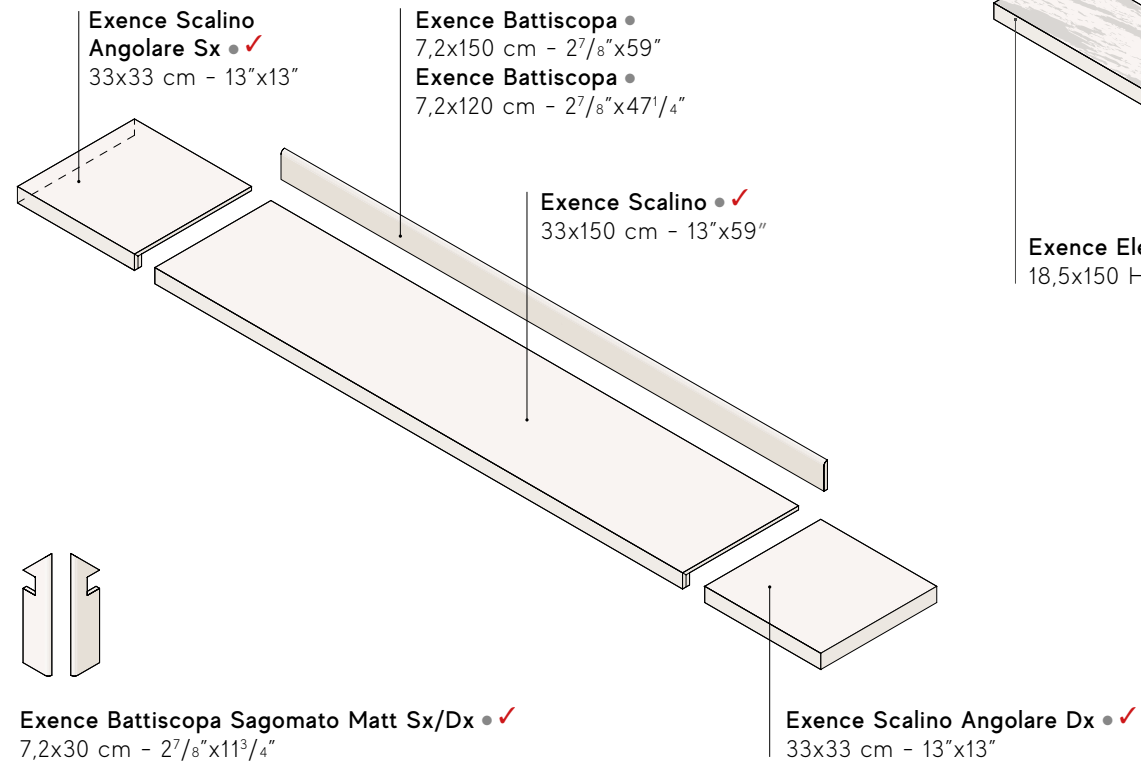

OUTDOOR TRIM TILES

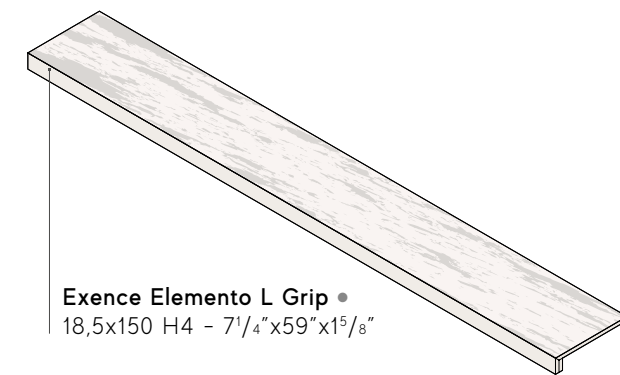

OUTDOOR TRIM TILES \pm 20 mm

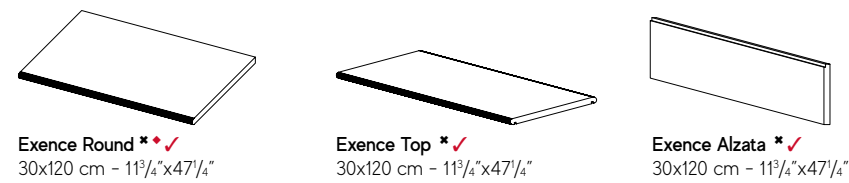

- ◆ Right/left angular elements are available / Sono disponibili gli elementi angolari dx/sx
- Available in the following colors: / Disponible nei seguenti colori: **Vanilla, Almond, Amber**
- * Available in the following colors: / Disponible nei seguenti colori: **Almond, Amber**
- ✓ These parts are supplied to order / I pezzi sono disponibili su ordinazione

NOTES / NOTE

For information and details relating to codes, packaging and weight it is recommended to refer to the latest pricelist. | Per le informazioni e i dati relativi a codici, imballaggi e pesi occorre sempre consultare l'ultimo listino aggiornato e in vigore. | Para acceder a la información y a los datos relativos a códigos, embalajes y pesos hay que consultar siempre la última lista de precios actualizada y vigente. | Für Informationen und Daten die den Code, die Verpackung und das Gewicht betreffen bitte die aktuellste Preisliste zugrunde legen. | Pour toutes informations et renseignements concernant les codes, les emballages et les poids, il y a toujours lieu de consulter le dernier tarif en vigueur et mis à jour. | Для информации о кодах, упаковках и весе обращайтесь к последнему действующему прайс-листу.

Colors and optical features of the materials illustrated in this catalogue are to be regarded as mere indications. | I colori e le caratteristiche estetiche dei materiali illustrati nel presente catalogo sono da ritenersi puramente indicativi. | Los colores y las características estéticas de los materiales ilustrados en el presente catálogo deben ser considerados como puramente indicativos. | Die Farben und die ästhetischen Eigenschaften der in diesem Katalog abgebildeten Produkte sind als reine Richtwerte zu betrachten. | Les coloris et les caractéristiques esthétiques des références illustrées dans le catalogue sont donnés à titre purement indicatif. | Цвета и эстетические характеристики описанных в настоящем каталоге материалов являются только ориентировочными.

Atlas Concorde reserves the right to modify any product without notice and will not be liable for any direct or indirect damage resulting from such modifications. | Atlas Concorde si riserva di modificare i prodotti senza preavviso, declinando ogni responsabilità su eventuali danni diretti o indiretti derivanti da eventuali modifiche. | Atlas Concorde se reserva el derecho de modificar los productos sin previo aviso, rechaza cualquier responsabilidad sobre eventuales daños directos o indirectos derivados de eventuales modificaciones. | Atlas Concorde behält sich das Recht vor jederzeit und ohne vorherige Ankündigung, die Produkte zu verändern, und lehnt jede Haftung bei direkten oder indirekten Schäden ab, die von diesen Veränderungen herrühren. | Atlas Concorde se réserve le droit de modifier ses produits sans préavis et décline toute responsabilité concernant les éventuels dommages directs ou indirects qui pourraient dériver de ces modifications. | Atlas Concorde оставляет за собой право изменять характеристики изделий без предварительного уведомления, отклоняя при этом любую ответственность за прямые или косвенные убытки, возникшие в результате изменений.



atlasconcorde

Ceramic and porcelain tiles: A safe choice

Resistance and duration

RESISTENZA E DURATA

Easy to maintain

Facile da mantenere



Porcelain tiles do not require any special maintenance.

Il gres porcellanato non richiede manutenzioni particolari.

UV Resistant

Resistente ai raggi UV



Porcelain tiles maintain their colors even when exposed to continuous, direct sunlight or in contact with atmospheric agents or smog.

Il gres porcellanato rimane inalterato nei suoi colori anche se esposto alla luce diretta e continua del sole o a contatto con agenti atmosferici o smog.

Scratch resistant

Resistente al graffio



Porcelain tiles do not splinter, break or get damaged.

Il gres porcellanato non si scheggia, non si rompe e non si danneggia.

Easy to clean

Facile da pulire



Porcelain tiles are easy to clean.

Il gres porcellanato si pulisce facilmente.

Waterproof

Resistente all'acqua



Porcelain tiles are completely non-porous and therefore are not damaged by water or humidity.

Il gres porcellanato è completamente non poroso e non teme l'acqua e l'umidità.

Stain resistant

Resistente alle macchie



Porcelain tiles are waterproof, no liquid can damage the surface.

Il gres porcellanato è impermeabile e nessun tipo di liquido può danneggiarne la superficie.

Resistant to chemicals

Resistente agli agenti chimici



Porcelain tiles do not stain and resist the most aggressive chemical agents.

Il gres porcellanato non si macchia e resiste agli agenti chimici più aggressivi.

Resistant to acids

Resistente agli acidi



Porcelain tiles are resistant to acids found in food and cleaning products.

Il gres porcellanato resiste agli acidi di uso alimentare e domestico.

Resistant to thermal shock

Resistente agli shock termici



A porcelain tile floor will not change as a result of sharp temperature fluctuations.

Un pavimento in gres porcellanato non si altera a causa di sbalzi termici.

Frost resistant

Resistente al ghiaccio



Porcelain tiles are frost resistant and therefore are not damaged by low temperatures.

Il gres porcellanato è ingelivo e resiste alle temperature più basse.

Health

SALUTE

Zero VOCS

Zero VOC



Porcelain tiles are intrinsically inorganic and do not emit volatile organic compounds (VOC).

Le piastrelle in gres porcellanato sono intrinsecamente inorganiche e non emettono composti organici volatili.

Zero PVC

Zero PVC



Porcelain tiles contain no PVC, plastics or petroleum derivatives.

Il gres porcellanato è privo di PVC, plastiche o derivati del petrolio.

Zero formaldehyde

Zero formaldeide



Porcelain tiles do not contain formaldehyde.

Il gres porcellanato non contiene formaldeide.

Zero allergens

Zero allergeni



Porcelain tiles are inhospitable for mites, bacteria, fungi, molds, and other irritants.

Il gres porcellanato è inospitale per acari, batteri, funghi, muffe e altre sostanze irritanti.

Prevent bacterial growth

Previene la crescita batterica



Porcelain tiles are completely hygienic and inhospitable for bacteria, mites, molds, and fungi.

Il gres porcellanato è assolutamente igienico e inospitale per i batteri, acari, muffe e funghi.

Non-slip
Antiscivolo



Porcelain tile surfaces can be made with an abrasive surface grit that can increase traction and reduce the risk of slipping.

Le superfici in gres porcellanato possono essere realizzate con una graniglia abrasiva superficiale in grado di aumentare la trazione e ridurre i rischi di scivolamento.

Fire resistant
Resistente al fuoco



Porcelain tiles are not flammable, reduce the spread of flames, do not burn, and do not emit toxic fumes.

Le piastrelle in gres porcellanato non sono infiammabili, riducono la propagazione della fiamma, non bruciano e non emettono fumi tossici.

Heat resistant
Resistente al calore



Porcelain tiles do not change shape at high temperatures.

Il gres porcellanato non si altera alle alte temperature.

Environment
AMBIENTE

Energy efficiency
Efficienza energetica



The high thermal inertia of porcelain tiles moderates the changes in temperature of the rooms, favoring energy savings.

L'elevata inerzia termica del gres porcellanato modera gli sbalzi di temperatura degli ambienti, favorendo il risparmio energetico.

Ecological
Ecologico



Porcelain tiles have a low environmental impact at all stages of their production, from the raw materials to disposal and recycling.

Il gres porcellanato ha un basso impatto ambientale in tutte le fasi del suo processo industriale, dalle materie prime fino allo smaltimento e al riciclo.

Recycling and re-use
Riciclo e riutilizzo



Porcelain tiles are made with recycled materials, last a long time, and can be re-used because they retain their original appearance.

Il gres porcellanato è realizzato con materiali di riciclo, dura a lungo e mantenendo l'aspetto originario può essere riciclato.

Ideal for floor heating systems

Ideale per sistemi di riscaldamento a pavimento



Porcelain tiles can be effectively combined with floor heating systems.

Il gres porcellanato può essere abbinato in modo efficace a sistemi di riscaldamento a pavimento.

Coloured body porcelain tiles - Rectified monocaliber



Compliant with standards EN 14411 annex G group Bla
Compliant with standards ISO 13006 annex G group Bla
Conforme alla norma EN 14411 Appendice G gruppo Bla
Conforme alla norma ISO 13006 Appendice G gruppo Bla

Gres porcellanato colorato in massa - Rettificato monocalibro

18,5x150 cm - 7 1/8"x59" ± 9 mm 30x120 cm - 12"x47 1/4" ± 20 mm
20x120 cm - 7 7/8"x59" ± 9 mm

Technical features Caratteristiche tecniche	Test Method Metodo di prova	Requirements for nominal size N / Requisiti per dimensione nominale N		
		7 cm ≤ N < 15 cm (mm)	N ≥ 15 cm (%)	(mm)
Length and width Lunghezza e larghezza	ISO 10545-2	± 0,9 (*)	± 0,6 (**)	± 2,0 (**)
Thickness Spessore		± 0,5 (***)	± 5 (***)	± 0,5 (***)
Straightness of sides Rettilinearità degli spigoli		± 0,75 (****)	± 0,5 (****)	± 1,5 (****)
Rectangularity (Measurement only on short edges when L/l ≥ 3) Ortogonalità (Misurazione da condurre solo sui lati corti quando L/l ≥ 3)		± 0,75 (****)	± 0,5 (****)	± 2,0 (****)
Surface flatness Planarità	ISO 10545-2	c.c. ± 0,75 e.c. ± 0,75 w. ± 0,75	c.c. ± 0,5 e.c. ± 0,5 w. ± 0,5	c.c. ± 2,0 e.c. ± 2,0 w. ± 2,0
Water absorption (in % by mass) Massa d'acqua assorbita (come % della massa)	ISO 10545-3 ASTM C 373-18	E _v ≤ 0,5% Individual Maximum 0,6% E _v ≤ 0,5% Valore massimo singolo 0,6% Requirement ANSI A137.1-2017 Water absorption max ≤ 0,5%		
Breaking strength Storzo di rottura	ISO 10545-4	S ≥ 700N (for thickness < 7,5 mm - per spessore < 7,5 mm) S ≥ 1300N (for thickness ≥ 7,5 mm - per spessore ≥ 7,5 mm) R ≥ 35 N/mm ²		
Modulus of rupture Resistenza alla flessione				
Bending strength and breaking load Resistenza a flessione e al carico di rottura (4)(5)	EN 1339 Annex F	-		
Impact resistance, as coefficient of restitution Resistenza all'impatto, espresso come coefficiente di restituzione	ISO 10545-5	Declared value Valore dichiarato		
Mohs hardness Durezza Mohs	EN 101	-		
Resistance to deep abrasion of unglazed tiles (removed volume) Resistenza all'abrasione profonda delle piastrelle non smaltate (volume materiale asportato)	ISO 10545-6	≤ 175 mm ³		
Coefficient of thermal linear expansion Coefficiente di dilatazione termica lineare	ISO 10545-8	Declared value Valore dichiarato		
Thermal shock resistance Resistenza agli sbalzi termici	ISO 10545-9	Pass according to EN ISO 10545-1 Test superato in accordo con ISO 10545-1		
Moisture expansion (in mm/m) Dilatazione all'umidità (in mm/m)	ISO 10545-10	Declared value Valore dichiarato		
Frost resistance Resistenza al gelo	ISO 10545-12	Pass according to EN ISO 10545-1 Test superato in accordo con ISO 10545-1		
Bond strength/adhesion for improved cementitious adhesives Adesione a trazione con adesivi cementizi migliorati	EN 1348	Declared value Valore dichiarato		
Reaction to fire Reazione al fuoco	-	Class A1 or A1 _s Classe A1 oppure A1 _s		
Resistance to household chemicals and swimming pool salts Resistenza ai prodotti chimici di uso domestico e agli additivi per piscina	ISO 10545-13	Minimum Class B Classe minima B		
Resistance to low concentrations of acids and alkalis Resistenza a basse concentrazioni di acidi e alcali		Declared Class Classe dichiarata		
Resistance to high concentrations of acids and alkalis Resistenza ad alte concentrazioni di acidi e alcali		Declared Class Classe dichiarata		
Resistance to staining for unglazed tiles Resistenza alle macchie per piastrelle non smaltate	ISO 10545-14	Declared Class Classe dichiarata		
Shod Ramp Test Metodo della rampa "calzata"	DIN 51130	Declared value Valore dichiarato		
Barefoot Ramp Test Metodo della rampa a piedi nudi	DIN 51097	Declared value Valore dichiarato		
Pendulum Friction Test Metodo del Pendolo	BS 7976	PTV ≥ 36 classifies the surface as "low slip risk"		
	AS 4586	Declared Classification of the new pedestrian surface materials according to the Pendulum Test		
	UNE-ENV 12633	Declared value Valore dichiarato		
Coefficient of friction (COF) Coefficiente di attrito	B.C.R.A. Rep. CEC/81	D. M. 236/R9 del 14/06/89 μ > 0,40 per elemento scivolante cuoio su pavimentazione asciutta μ > 0,40 per elemento scivolante gomma dura su pavimentazione bagnata		
Dynamic coefficient of friction (DCOF) Coefficiente di attrito dinamico	ANSI A137.1	ANSI A.137.1-2017 Requires a minimum value of 0.42 for level interior space expected to be walked upon when wet. (3)		

(*) The permissible deviation, in % or mm, of the average size for each tile (2 or 4 sides) from work size (WS). Deviazione ammissibile, in % oppure mm, della dimensione media di ogni piastrella (2 oppure 4 lati) dalla dimensione di fabbricazione (WS).
 (**) The permissible deviation, in % or mm, of the average thickness for each tile from the work size thickness (WS). Deviazione ammissibile, in % oppure mm, dello spessore medio di ogni piastrella dallo spessore riportato nella dimensione di fabbricazione (WS).
 (***) The maximum permissible deviation from straightness, in % or mm, related to the corresponding work sizes (WS). Deviazione massima ammissibile di rettilineità, in % oppure mm, in rapporto alle dimensioni di fabbricazione (WS) corrispondenti.
 (****) The maximum permissible deviation from rectangularity, in % or mm, related to the corresponding work sizes (WS). Deviazione massima ammissibile di ortogonalità, in % oppure mm, in rapporto alle dimensioni di fabbricazione (WS) corrispondenti.
 c.c. The maximum permissible deviation from centre curvature, in % or mm, related to the corresponding work sizes (WS). Deviazione massima ammissibile della curvatura del centro, in % oppure mm, in rapporto alla diagonale calcolata secondo le dimensioni di fabbricazione (WS).
 e.c. The maximum permissible deviation from edge curvature, in % or mm, related to the corresponding work sizes (WS). Deviazione massima ammissibile della curvatura dello spigolo, in % oppure mm, in rapporto alle dimensioni di fabbricazione (WS) corrispondenti.
 w. The maximum permissible deviation from warpage, in % or mm, related to the corresponding work sizes (WS). Deviazione massima ammissibile dello svergolamento, in % oppure mm, in rapporto alla diagonale calcolata secondo le dimensioni di fabbricazione (WS).
 (1). Determination of slip resistance of pedestrian surfaces; it does not cover sports surfaces and road surfaces for vehicles (skid resistance). Determinazione della resistenza allo scivolamento delle superfici pedonabili; non si applica alle pavimentazioni sportive ed alle pavimentazioni stradali veicolari.
 (2). Anti-slip performance is guaranteed at the time of delivery of the product. Le prestazioni anti-slip vengono garantite al momento della consegna del prodotto.
 (3). However, tiles with a DCOF of 0.42 or greater are not necessarily suitable for all projects. The specifier shall determine tiles appropriate for specific project conditions, considering by way of example, but not in limitation, type of use, traffic, expected contaminants, expected maintenance, expected wear, and manufacturers' guidelines and recommendations.
 (4). For further details, please refer to outdoor design general catalogue. Per maggiori informazioni riferirsi al catalogo generale Outdoor Design.
 (5). Only for products with 20 mm thickness. Solo per prodotti a 20mm di spessore.
 (6). If not rectified: "Suitable for". Se non rettificato: "Conforme".

LE GRÈS CÉRAME : LE CHOIX SÛR / DAS FEINSTEINZEUG: EINE SICHERE WAHL / GRES PORCELÁNICO: LA ELECCIÓN SEGURA / КЕРАМИКА: НАДЕЖНЫЙ ВЫБОР

Le grès cérame

Résistance et longévité / Widerstandsfähigkeit und lebensdauer / Resistencia y durabilidad / Стойкость и долговечность

Le grès cérame

Entretien facile / Leicht zu warten / Fácil de mantener / Простота ухода

Le grès cérame n'exige aucun entretien particulier. / Feinsteinzeug erfordert keine besonderen Wartungsarbeiten. / El gres porcelánico no requiere particulares operaciones de mantenimiento. / Керамогранит не нуждается в особом уходе.

Le grès cérame

Résistant aux rayons UV / UV-Strahlenfest / Resistente a los rayos UV / Стойкость к УФ-излучению

Les coloris du grès cérame restent inaltérés même s'il est exposé à la lumière directe et continue du soleil ou au contact du smog et des agents atmosphériques. / Die Farben des Feinsteinzeugs bleiben unverändert erhalten, auch wenn es direktem und ständigem Sonnenlicht, der Witterung oder Smog ausgesetzt ist. / El gres porcelánico no se altera con el paso del tiempo, tampoco cambia su color cuando está expuesto a la luz directa y continua del sol o cuando entra en contacto con agentes climatológicos o contaminación. / Керамогранит не выцветает даже при постоянном воздействии солнечного света, атмосферных факторов, смога.

Le grès cérame

Résistant aux rayures / Kratzfestigkeit / Resistente a las rayas / Стойкость к царапинам

Le grès cérame

Le grès cérame ne subit ni ébréchures, ni cassures, ni dommages. / Feinsteinzeug splittert nicht, es zerbricht nicht und erleidet keine Beschädigungen. / El gres porcelánico no se desportilla, no se rompe y no se estropea. / Керамогранит не раскалывается, не ломается, не повреждается.

Le grès cérame

Facile à nettoyer / Leicht zu reinigen / De fácil limpieza / Легкость чистки

Le grès cérame se nettoie facilement. / Feinsteinzeug kann leicht gereinigt werden. / El gres porcelánico se limpia fácilmente. / Керамогранит легко очищается.

Le grès cérame

Résistant aux taches / Fleckenfestigkeit / Resistente a las manchas / Стойкость к пятнам

Le grès cérame est imperméable et aucun type de liquide ne peut endommager sa surface. / Feinsteinzeug ist wasserundurchlässig und Flüssigkeiten jeglicher Art können seine Oberfläche nicht beschädigen. / El gres porcelánico es impermeable y ningún tipo de líquido puede estropear la superficie. / Керамогранит непроницаем, и никакая жидкость не может повредить его поверхность.

Le grès cérame

Résistant aux agents chimiques / Beständigkeit gegen chemikalien / Resistente a los agentes químicos / Стойкость к химическим веществам

Le grès cérame ne se tache pas et résiste aux agents chimiques les plus agressifs. / Feinsteinzeug ist fleckenfest und beständig gegen die aggressivsten Chemikalien. / El gres porcelánico no se mancha y es resistente a los agentes químicos más agresivos. / Даже самые агрессивные химикаты не повреждают керамогранит и не оставляют на нем пятен.

Le grès cérame

Résistant aux acides / Beständigkeit gegen säuren / Resistente a los ácidos / Стойкость к кислотам

Le grès cérame résiste aux acides d'usage alimentaire et domestique. / Feinsteinzeug ist beständig gegen Säuren, die in Nahrungsmitteln oder im Haushalt verwendet werden. / El gres porcelánico es resistente a los ácidos de uso alimenticio y doméstico. / Керамогранит устойчив к кислотам, входящим в состав пищевых продуктов и средств бытовой химии.

Le grès cérame

Résistant aux écarts thermiques / Beständigkeit gegen thermoschocks / Resistente a los choques térmicos / Стойкость к перепадам температур

Le grès cérame

Un sol en grès cérame ne subit aucune altération suite aux écarts thermiques. / Ein Feinsteinzeug-Fußboden wird von Temperaturschwankungen nicht beeinträchtigt. / El pavimento de gres porcelánico no cambia a causa de cambios bruscos de temperatura. / Напольные покрытия из керамогранита не разрушаются при перепадах температуры.

Le grès cérame

Résistant à l'eau / Wasserfestigkeit / Resistente al agua / Стойкость к воде

Le grès cérame

Le grès cérame est absolument non poreux et ne craint ni l'eau ni l'humidité. / Feinsteinzeug ist absolut porös und fürchtet weder Wasser noch Feuchtigkeit. / El gres porcelánico no es poroso, no le penetra el agua y es resistente a la humedad. / Керамогранит – абсолютно непористый материал, поэтому не боится воды и влаги.

Le grès cérame

Résistant au gel / Frostbeständigkeit / Resistente a las heladas / Стойкость к морозам

Le grès cérame

Le grès cérame est îngélif et résiste aux températures les plus basses. / Feinsteinzeug ist frostbeständig und widersteht den niedrigsten Temperaturen. / El gres porcelánico es resistente a las heladas y a las bajas temperaturas. / Керамогранит способен противостоять морозам и низким температурам.

Le grès cérame

Le grès cérame

Le grès cérame

Santé / Gesundheit / Salud / Здоровье

Le grès cérame

Zéro allergène / Null allergene / Cero alérgenos / Ноль аллергенов

Le grès cérame est inhospitalier vis-à-vis des acariens, bactéries, champignons, moisissures et autres substances irritantes. / Feinsteinzeug ist ungestlich für Milben, Bakterien, Pilze, Schimmel und andere Reizstoffe. / El gres porcelánico es inhóspito para los ácaros, bacterias, hongos, mohos y otras sustancias irritantes. / На поверхности керамогранита не накапливаются клещи, бактерии, грибки, плесень и другие болезнетворные микроорганизмы.

Le grès cérame

Zéro COV / Null VOC / Cero VOC / Ноль летучих органических соединений

Les carreaux en grès cérame sont intrinsèquement inorganiques et ne libèrent aucun composé organique volatil. / Feinsteinzeugfliesen sind von Natur aus anorganisch und setzen keine flüchtigen organischen Verbindungen frei. / Las baldosas de gres porcelánico son intrínsecamente inorgánicas y no emiten compuestos orgánicos volátiles. / Керамогранит является неорганическим материалом и не выделяет летучих органических соединений.

Le grès cérame

Zéro formaldéhyde / Null formaldehyd / Cero formaldehído / Ноль формальдегида

Le grès cérame ne contient pas de formaldéhyde. / Feinsteinzeug ist formaldehydfrei. / El gres porcelánico non contiene formaldehído. / Керамогранит не содержит формальдегид.

Le grès cérame

Zéro PVC / Null PVC / Cero PVC / Ноль ПВХ

Le grès cérame

Le grès cérame est privé de PVC, de matières plastiques et de dérivés du pétrole. / Feinsteinzeug ist frei von PVC, Kunststoffen oder Petroleumderivaten. / El gres porcelánico no contiene PVC, plástico o sustancias que derivan del petróleo. / Керамогранит не содержит ПВХ, пластиковых материалов, нефтепродуктов.

Le grès cérame

Il prévient la croissance bactérienne / Vorbeugung gegen das wachstum von bakterien / Previene la proliferación de bacterias / Предотвращение развития бактерий

Le grès cérame

Le grès cérame est absolument hygiénique et inhospitalier vis-à-vis des bactéries, acariens, moisissures et champignons. / Feinsteinzeug ist absolut hygienisch und ungestlich für Bakterien, Milben, Schimmel und Pilze. / El gres porcelánico es totalmente higiénico e inhóspito para las bacterias, ácaros, mohos y hongos. / Керамогранит абсолютно гигиеничен и препятствует развитию бактерий, клещей, плесени, грибка.

Le grès cérame

Le grès cérame

Le grès cérame

Sécurité / Sicherheit / Seguridad / Безопасность

Le grès cérame

Antiglisse / Rutschfestigkeit / Antideslizante / Препятствование скольжению

Les surfaces en grès cérame peuvent être réalisées avec un fond superficiel abrasif en mesure d'augmenter la traction et réduire le risque de glissade. / Die Oberflächen des Feinsteinzeugs können mit die Reibung erhöhenden Splitten bereichert werden, welche die Trittsicherheit verbessern und die Gefahr von Ausrutschern mindern. / Las superficies de gres porcelánico se fabrican con una granalla abrasiva superficial en grado de aumentar la tracción y reducir los riesgos de deslizamiento. / На поверхность керамогранитной плитки в процессе изготовления может наноситься специальная абразивная крошка, которая увеличивает сцепление и снижает риск скольжения.

Le grès cérame

Résistant au feu / Feuerfestigkeit / Resistente al fuego / Огнестойкость

Le grès cérame

Les carreaux en grès cérame sont ininflammables, ils réduisent la propagation de la flamme, ne brûlent pas et de libèrent aucune fumée toxique. / Feinsteinzfliesen sind nicht entflammbar, sie mindern die Flammenausbreitung, brennen nicht und setzen keinen toxischen Rauch frei. / Las baldosas de gres porcelánico no son inflamables, reducen la propagación de las llamas, son resistentes al fuego y no emiten humos tóxicos. / Керамогранитная плитка не воспламеняется, ограничивает распространение огня, не горит, не выделяет токсичного дыма.

Le grès cérame

Résistant à la chaleur / Wärmebeständigkeit / Resistente al calor / Термостойкость

Le grès cérame

Le grès ne subit aucune altération aux températures élevées. / Feinsteinzeug wird von hohen Temperaturen nicht verändert. / El gres porcelánico no se altera con las altas temperaturas. / Керамогранит не повреждается под действием высоких температур.

Le grès cérame

Environnement / Umwelt / Ambiente / Окружающая среда

Le grès cérame

Efficacité énergétique / Energieeffizienz / Eficiencia energética / Энергоэффективность

Le grès cérame

La haute inertie thermique du grès cérame modère les écarts de température à l'intérieur des pièces, en favorisant ainsi les économies d'énergie. / Die hohe Wärmeträgheit des Feinsteinzeugs reduziert starke Temperaturschwankungen in den Räumen und ermöglicht demzufolge eine Energieeinsparung. / La elevada inercia térmica del gres porcelánico modera los cambios de temperatura de los ambientes, favoreciendo el ahorro energético. / Высокая тепловая инерция керамогранита сглаживает колебания температуры в помещениях, что позволяет значительно экономить энергию.

Le grès cérame

Écologique / Ökologisch / Ecológico / Экологичность

Le grès cérame a un faible impact sur l'environnement durant toutes les phases de son processus industriel, à partir des matières premières jusqu'à l'élimination et au recyclage. / In allen Phasen seines Herstellungsprozesses verursacht das Feinsteinzeug eine geringfügige Umweltbelastung, angefangen beim Abbau der Rohstoffe bis zur Entsorgung und zum Recykling. / El gres porcelánico tiene un bajo impacto ambiental en todas las fases de su proceso industrial, dese las materias primas hasta la eliminación y el reciclaje. / Керамогранит имеет низкое воздействие на окружающую среду на всем протяжении жизненного цикла: от добычи сырья до переработки и утилизации.

Le grès cérame

Recyclage et réutilisation / Recykling und wiederverwertung / Reciclaje y reutilización / Переработка и утилизация

Le grès cérame est fabriqué avec des matériaux de recyclage, il dure longtemps en maintenant son aspect d'origine et il est recyclable. / Feinsteinzeug wird aus Recycling-Material hergestellt, hat eine lange Lebensdauer, erhält sein ursprüngliches Aussehen und kann recycelt werden. / El gres porcelánico está fabricado con materiales de reciclado, es duradero al paso del tiempo y se puede reciclar manteniendo el aspecto original. / Керамогранит изготавливается из переработанных материалов, долговечен, сохраняет во времени свои первоначальные характеристики и поддается переработке.

Le grès cérame

Idéal pour les systèmes de chauffage au sol / Ideal für fussbodenheizsysteme / Indicado para los sistemas de calefacción por suelo radiante / Идеальное решение для теплого пола

Le grès cérame peut être associé de manière efficace à des systèmes de chauffage au sol. / Feinsteinzeug ist optimal leistungsfähig in Verbindung mit Fußbodenheizsystemen. / El gres porcelánico se puede utilizar eficazmente con sistemas de calefacción por suelo radiante. / Керамогранит отлично подходит для облицовки полов с подогревом.

Green Project

Sustainability / Sostenibilità

In the environmental and economic sciences, sustainability is defined as the condition of development capable of ensuring the satisfaction of the needs of the present generation without compromising the ability of future generations to realize their own. Several international certifications guarantee that the Atlas Concorde products meet the criteria of sustainable construction, attesting to their low impact on the ecosystem, compliance with declared standards and attention to comfort.

Nelle scienze ambientali ed economiche, la sostenibilità è definita come condizione di uno sviluppo in grado di assicurare il soddisfacimento dei bisogni della generazione presente senza compromettere la possibilità delle generazioni future di realizzare i propri. Diverse certificazioni internazionali garantiscono che i prodotti Atlas Concorde rispondono ai criteri del costruire sostenibile, attestandone il basso impatto sull'ecosistema, la conformità agli standard dichiarati e l'attenzione al comfort abitativo.

Certifications / Certificazioni



ISO 9001

In 1995 Atlas Concorde obtained ISO 9001 quality certification for its products. It is an international recognition referring to the company's entire quality system, from the receipt of raw materials to their transformation, from the distribution of the product to their placement on the market.

Sin dal 1995 Atlas Concorde ha ottenuto per i propri prodotti la certificazione di qualità ISO 9001. Si tratta di un riconoscimento internazionale riferito all'intero sistema di qualità aziendale, dall'ingresso delle materie prime alla loro trasformazione, dalla distribuzione del prodotto alla sua immissione sul mercato.

LEED V4*

All Atlas Concorde porcelain floor and white body wall tiles can be used in projects that follow the guidelines of the GREEN BUILDING COUNCIL, which promotes the independent certification system LEED BD&C v4 (Leadership in Energy and Environmental Design, Building Design & Construction), whose parameters establish precise criteria for the design and construction of buildings that are healthy, energy efficient and with low environmental impact. All our products in porcelain stoneware and in white clay can therefore contribute to obtaining the LEED V4 rating of buildings, in relation to different areas: Sustainable Sites, Materials and Resources, Internal Environmental Quality.

Tutti i prodotti in gres porcellanato e in pasta bianca Atlas Concorde possono essere utilizzati in progetti che seguono le linee guida del GREEN BUILDING COUNCIL, che promuove il sistema di certificazione indipendente LEED BD&C v4 (Leadership in Energy and Environmental Design, Building Design & Construction), i cui parametri stabiliscono precisi criteri di progettazione e realizzazione di edifici salubri, energeticamente efficienti e a impatto ambientale contenuto. Tutti i nostri prodotti in gres porcellanato e in pasta bianca possono quindi contribuire all'ottenimento del rating LEED V4 degli edifici, relativamente a diverse aree tematiche: Siti Sostenibili, Materiali e Risorse, Qualità ambientale Interna.

EPD

Atlas Concorde also has an EPD declaration, which attests to the environmental sustainability of its products. The EPD (Environmental Product Declaration) also assesses the life cycle of a product, from extraction to production, transport, installation, maintenance, and cleaning. Atlas Concorde's EPD declaration was certified by the independent certifying body EPD ITALY.

Atlas Concorde dispone inoltre di una dichiarazione EPD, che attesta la sostenibilità ambientale dei prodotti. Anche la EPD (Environmental Product Declaration) valuta il ciclo di vita di un prodotto, dall'estrazione all'utilizzo passando per la produzione, il trasporto, l'installazione, la manutenzione e la pulizia. La dichiarazione EPD di Atlas Concorde è stata certificata dall'ente di certificazione indipendente EPD ITALY.

PEF*

The environmental footprint of products (PEF, Product Environmental Footprint, according to Recommendation 2013/179/EU) is a measurement that, based on various criteria, indicates the environmental performance of a product or service over its lifetime, taking into account supply chain activities: from the extraction of raw materials, to the production, use, and end of life of the product. Atlas Concorde has a verified PEF. Atlas Concorde's PEF was verified by the DNV-GL certifying body.

L'impronta ambientale dei prodotti (PEF, Product Environmental Footprint, secondo la Raccomandazione 2013/179/UE) è una misura che, sulla base di vari criteri, indica le prestazioni ambientali di un prodotto o servizio nel corso del proprio ciclo di vita, tenendo conto delle attività della catena di approvvigionamento: dall'estrazione di materie prime, alla produzione, all'uso e fine vita del prodotto. Atlas Concorde dispone di una PEF verificata. La PEF di Atlas Concorde è verificata dall'organismo di certificazione DNV-GL.

FDES*

Atlas Concorde has also drafted an FDES environmental declaration (Fiche de déclaration environnementale et sanitaire), this also having the purpose of transparently disclosing the product's impact, covering each phase from product extraction to production and finally laying and use.

Atlas Concorde ha realizzato inoltre la dichiarazione ambientale FDES (Fiche de déclaration environnementale et sanitaire), anch'essa con lo scopo di rendicontare in modo trasparente l'impatto del prodotto, a partire dalla fase di estrazione del prodotto, passando dalla fase di produzione, fino alla posa ed all'utilizzo.

HPD

Atlas Concorde has a HPD (Health Product Declaration) declaration, a complete report on the health characteristics of the finished product, compiled according to the HPD standard.

Atlas Concorde dispone della dichiarazione HPD (Health Product Declaration), un report completo sulle caratteristiche di salubrità del prodotto finito, compilato secondo lo standard HPD.

CAM/ISO 14021

An environmental declaration according to the ISO 14021 international standard, observance of Minimum Environmental Criteria, and the adoption of sustainability policies demonstrate Atlas Concorde's attention to environmental issues and allow the inclusion of its products in Green Public Tenders.

La dichiarazione ambientale secondo lo standard internazionale ISO 14021 ed il rispetto dei requisiti dei Criteri Ambientali Minimi permette ad Atlas Concorde, grazie all'adozione di politiche di sostenibilità, di dimostrare l'attenzione alle problematiche ambientali e proporre l'inserimento dei propri prodotti negli Appalti Pubblici Verdi.

For further details, please refer to / Per ulteriori dettagli, fare riferimento a: atlasconcorde.com



MADE IN ITALY. MADE TO EXCEL.

MADE IN ITALY

The Made in Italy logo of Atlas Concorde stands for style, quality and ethics. Having firmly adhered to the Ethical Code promoted by Confindustria Ceramica, Atlas Concorde places the Made in Italy logo on all the products designed and produced in Italy, that is to say ceramic tiles, decorations and the majority of special trim tiles. Only a small amount of the latter is manufactured in Spain. Atlas Concorde products are produced using eco-friendly technologies, top quality and safe raw materials with the best working conditions guaranteed for our personnel. For these reasons, Atlas Concorde's Made in Italy is the expression of strong values such as style, design, product quality, and respect for the environment and the people who live in it.

Il marchio Made in Italy di Atlas Concorde è sinonimo di stile, qualità ed etica. Avendo aderito con convinzione al Codice Etico di Confindustria Ceramica, Atlas Concorde appone il marchio Made in Italy su tutti i prodotti studiati, progettati e realizzati in Italia, nella fattispecie tutte le piastrelle di ceramica, le decorazioni e la maggioranza dei pezzi speciali. Solo un ristretto numero di questi ultimi è fabbricato in Spagna. I prodotti Atlas Concorde sono inoltre realizzati con tecnologie rispettose dell'ambiente, utilizzando materie prime eccellenti e sicure, garantendo le migliori condizioni di lavoro. Per queste ragioni il Made in Italy di Atlas Concorde è espressione di valori forti quali stile, design, qualità del prodotto, attenzione all'ambiente e alle persone.



The Ceramics of Italy logo is an exclusive identification on ceramic products which have effectively been made in Italy by companies that are a part of the Confindustria Ceramica and who adhered to its Ethical Code. This Code, promoted and created by Confindustria Ceramica, commits all companies to communicate, clearly and with transparency, the origin of their products.

Il marchio Ceramics of Italy contrassegna esclusivamente i prodotti ceramici effettivamente realizzati in Italia da un'azienda associata a Confindustria Ceramica che ha sottoscritto il Codice Etico. Il Codice, redatto dalla stessa Confindustria Ceramica, impegna a comunicare con chiarezza l'origine dei prodotti.

www.ceramica.info

CERAMICHE ATLAS CONCORDE S.p.A.
Via Canaletto 141
41042 Spezzano di Fiorano (MO) - Italia

ATLAS CONCORDE USA, Inc.
117 Seaboard Lane - Suite 170
Franklin, TN 37067 - USA

ATLAS CONCORDE RUSSIA
Business centre "Meliora Place"
Prospekt Mira 6, 129090 Moscow - Russia

atlasconcorde.com

Copyright 2020 by Ceramiche Atlas Concorde S.p.A.
(Spezzano di Fiorano, MO - Italy)
February 2020

