



HAMMER

WOW

HAMMER

Do you know reactive colours?

They are glazes with an anomalous chemical composition that favours their reactivity, obtaining different effects.

To deepen the good looks we developed a subtle hammered surface , enriching and adding a handmade feel to top off the final result.

Distinctive finish that makes each piece one of a kind.

-

Conoces los colores reactivos?

Son esmaltes de composición química anómala que favorece su reactividad, obteniendo distintos efectos.

Para enfatizar su apariencia hemos desarrollado una sutil superficie martilleada, enriqueciendo y aportando un toque hecho a mano que redondea el resultado final.

Acabado distintivo que hace que cada pieza sea única.

01. SIZES, COLOURS AND FINISHES / FORMATOS, COLORES Y ACABADOS	<i>pag. 5</i>
02. GET INSPIRED / INSPIRATE	<i>pag. 6</i>
03. RECOMMENDATIONS / RECOMENDACIONES	<i>pag. 24</i>
04. TECHNICAL FEATURES / CARACTERÍSTICAS TÉCNICAS	<i>pag. 25</i>
05. TECHNICAL DRAWINGS / DIBUJOS TÉCNICOS	<i>pag. 26</i>
06. PACKING	<i>pag. 27</i>
07. PRICE CODE CÓDIGO DE TARIFA	<i>pag. 27</i>



HAMMER

HAMMER 5x15 cm / 2"x6"



Salt



Aqua



Grape



Topaz



Emerald

HAMMER DECOR 5x15 cm / 2"x6"



Salt



Aqua



Grape



Topaz



Emerald



* 10 different patterns randomly mixed within the box / * 10 diseños diferentes encajados aleatoriamente

IMPORTANT INFORMATION / INFORMACIÓN IMPORTANTE

Hammer pieces crackle effect varies depending on the colour version as it is inherent to some glazes. Salt and Aqua colours do not crackle.

El efecto craquelado varía dependiendo de la versión de color, ya que es inherente a algunos esmaltes. Los colores Salt y Aqua no craquelan.



Hammer Topaz ▶
Hammer Decor Topaz

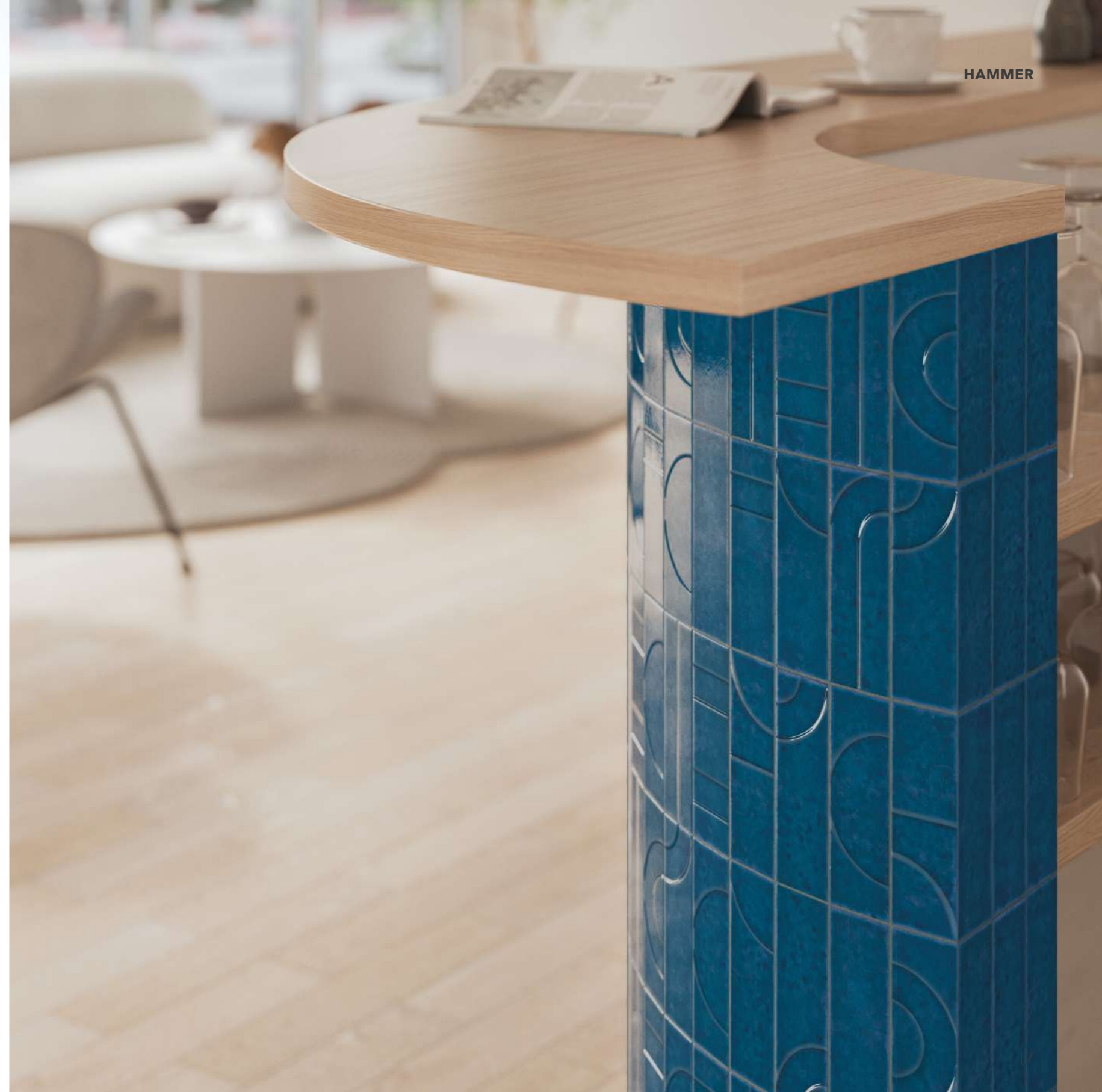

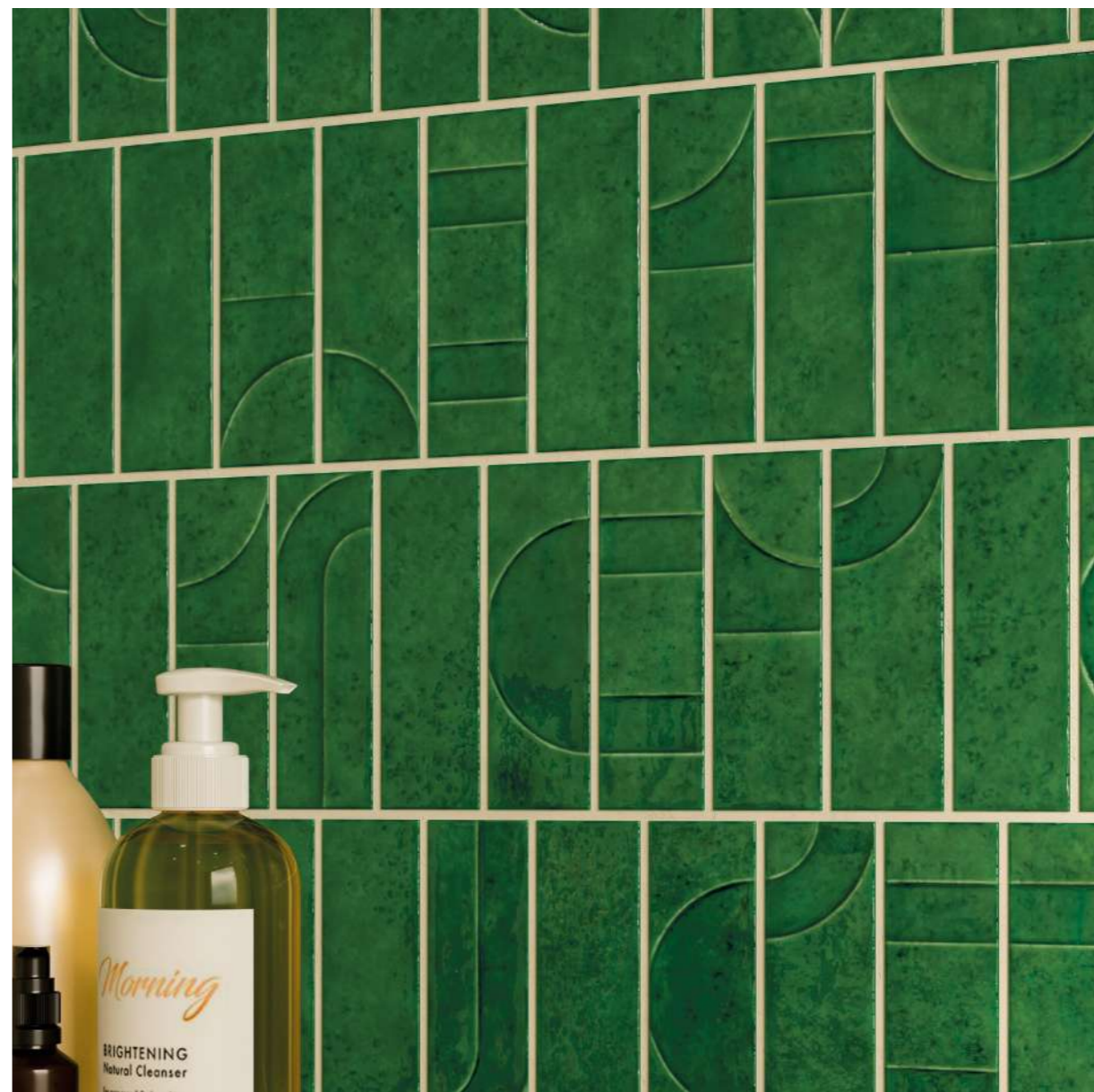

◀ Hammer Emerald - 25%
Hammer Decor Emerald - 75%



Hammer Salt - 75% ▶
Hammer Decor Salt - 25%
Floor Tiles: **Abbey Stone L Rila**

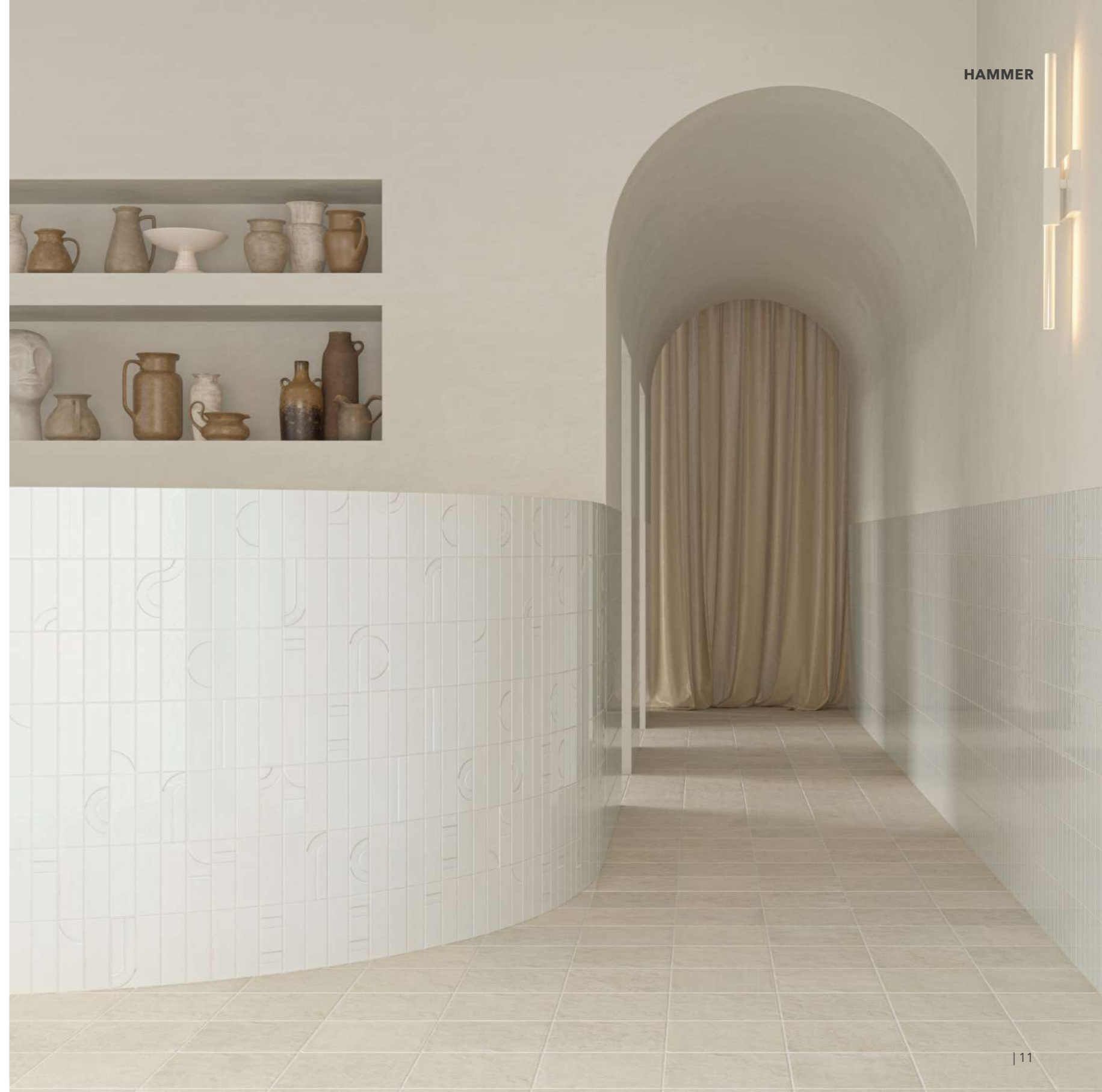



Hammer Salt - 85%
Hammer Decor Salt - 15%

◀ Hammer Grape
Hammer Decor Grape



Hammer Aqua ▶
Hammer Decor Aqua





◀ Hammer Topaz - 75%
Hammer Decor Topaz - 25%



Detail

Hammer Emerald ▶
Hammer Decor Emerald
Floor Tiles: **Roots M Sand**





Hammer Salt - 81%
Hammer Decor Salt - 19%

◀ **Hammer Aqua**
Hammer Decor Aqua



Detail

Hammer Grape - 67% ▶
Hammer Decor Grape - 33%

Floor Tiles: **Roots M & S Sand**



WAREHOUSING

In order to guarantee the characteristics of the finish the product must be kept in its original packaging until the time of fixing. If the product is likely to be stored for a long period of time it should be suitably covered.

TILE FIXING

To ensure the products adhere correctly to the surface, it is essential to use specific adhesive and grouting material. This must also be suitable for the environment they will have to withstand. Fitting with traditional mortars does not ensure good adhesion.

Due to the nature of the material there may be dimensional variations between pieces. Therefore, all types of joints must be planned and carried out correctly: structural, perimeter, expansion and installation joints. Fitting tiles without joints is not advisable from any technical point of view as this may lead to various problems. For an optimal result we advise to use 2 mm (0.08") grout.

MAINTENANCE AND CLEANING

ATTENTION! NOT RESISTANT TO ACIDIC CLEANING PRODUCTS.

As a general guideline, powder detergents should not be used, not wire wool or abrasive materials. Generally a sponge will be sufficient with warm water and liquid **neutral** soap. Then rinse with plenty of clean water.

CHROMATIC VARIATION

Hammer Collection has been designed with a high chromatic variation between pieces. Prior to any installation, range of tiles should be checked by the client. No claims will be accepted after installation.

WARNING!

This collection reproduces traditional hand made tiles, this is the reason why there are slight dimensional differences between pieces (variable lengths and widths), which are part of the intended aesthetic. It is advised to adjust each one of the pieces in the process of installation due to the dimensional differences, instead of using spacers. As a result, these differences give the character, craftsman feel and a high aesthetic value.

ALMACENAMIENTO

Para garantizar las características de su acabado, el producto debe mantenerse en su embalaje original hasta el momento de la colocación. Si el producto va a permanecer almacenado durante un largo periodo es conveniente hacerlo bajo cubierta.

COLOCACIÓN

Para garantizar una buena adhesión al soporte es necesaria la utilización de materiales de agarre y de rejuntado adecuados al ambiente al que vayan a estar sometidos. La colocación con morteros tradicionales no garantiza una buena adhesión.

Debido a la naturaleza del material pueden existir diferencias dimensionales entre piezas. Por ello deberán planificarse y ejecutarse correctamente todo tipo de juntas: estructurales, perimetrales, de dilatación y de colocación. La colocación sin juntas es desaconsejable desde cualquier punto de vista técnico, pudiendo ser el origen de diversas patologías. Para un resultado óptimo recomendamos usar 2 mm de junta.

MANTENIMIENTO Y LIMPIEZA

¡ATENCIÓN! NO RESISTENTE A PRODUCTOS DE LIMPIEZA ÁCIDOS.

Como norma general no deben utilizarse detergentes en polvo ni estropajos metálicos o abrasivos. Generalmente será suficiente con una esponja, agua tibia y un jabón líquido **neutro**. Posteriormente aclarar con abundante agua limpia.

VARIACIÓN CROMÁTICA









La colección Hammer ha sido diseñada con una alta variación de tono entre piezas. Es importante verificar el producto antes de su instalación puesto que ninguna reclamación será aceptada una vez instalado.

¡ATENCIÓN!

Esta colección reproduce azulejos tradicionales hechos a mano, por esta razón existen ligeras diferencias dimensionales entre piezas (largos y anchos variables), que forman parte de la estética final que se busca. Es recomendable la instalación ajustando a mano cada una de las piezas debido a las diferencias dimensionales en vez de utilizar separadores. Estas diferencias son las que aportan su carácter, aspecto artesano y un resultado final de alto valor estético.

Dry-pressed porcelain tiles with water absorption B la ≤ 0,5% for interior and exterior floors and walls.

Baldosas cerámicas prensadas en seco con absorción de agua B la ≤ 0,5% para suelos y paredes interiores y exteriores.

FEATURES / CARACTERÍSTICAS	SPECIFICATION / ESPECIFICACIÓN	NORMA
 Dimensional Features	48 mm +/- 0,9 mm x 148 mm +/- 0,6% x 10 mm +/- 5%	UNE-EN ISO 10545-2:1998
 Modulus of rupture	Minimum 35 N/mm ² Individual Minimum 32 N/mm ²	UNE-EN ISO 10545-4:2012
 Frost resistance	Pass	UNE-EN ISO 10545-11:1997
 Household products resistance	GA (Salt) GB (Aqua, Grape, Topaz, Emerald)	UNE-EN ISO 10545-13:1998
 Chemical resistance	GHA (Salt) GLC (Aqua, Grape, Topaz, Emerald)	UNE-EN ISO 10545-13:1998
 Stain resistance	5	UNE-EN ISO 10545-14:1998
 Tone variation	V5	-
 Porcelain body	-	-

05. TECHNICAL DRAWINGS / DIBUJOS TÉCNICOS

Hammer

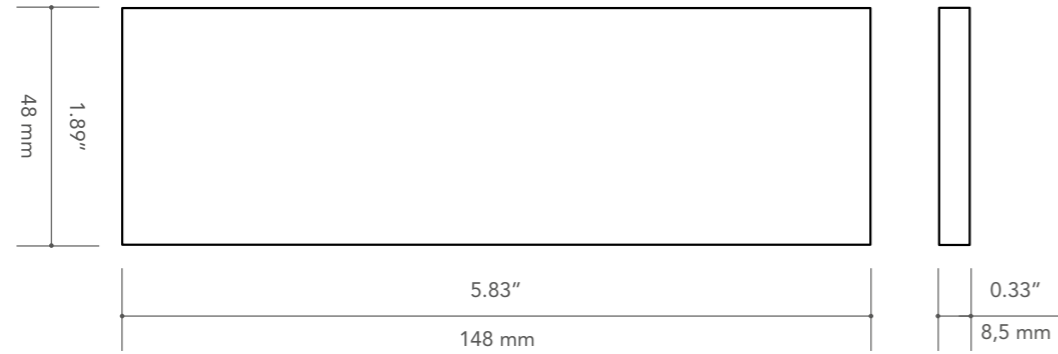

Hammer Decor

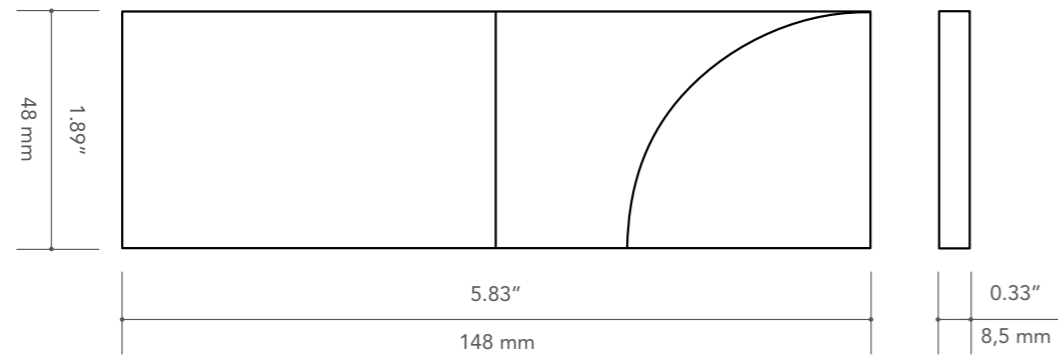

06. PACKING

Modelo Model	Tamaño (cm) Size (cm)	Piezas/caja Pieces/box	Kg/caja kg/box	m ² /caja m ² /box	Cajas/palet Box/pallet	m ² /palet m ² /pallet
Hammer	5x15 cm	75	10,10 kg	0,533 m ²	100	53,300 m ²
Hammer Decor	5x15 cm	75	10,10 kg	0,533 m ²	100	53,300 m ²

Model	Size (in)	Pieces/box	lb/box	sq ft/box	Box/pallet	sq ft/pallet
Hammer	2"x6"	75	22.27 lb	5.737 sq ft	100	573.70 sq ft
Hammer Decor	2"x6"	75	22.27 lb	5.737 sq ft	100	573.70 sq ft

07. PRICE CODE / CÒDICO DE TARIFA

W25	W27	W37	W38
Hammer Salt	Hammer Decor Salt	Hammer Aqua, Grape, Topaz & Emerald.	Hammer Decor Aqua, Grape, Topaz & Emerald.

Designed by



Polígono Pont, Avda. de España 114
12180 Cabanes,
Castellón (Spain)
t. +34 964 331 910 / f. +34 964 331 911

wowdesigneu.com
comercial@wowdesigneu.com



©2023 Tendencias Cerámicas

WOW, registered trademark of Tendencias Cerámicas, S.L.

The brand use or reproduction of the contents of this catalog, is protected by copyright law. Any use of the brand or reproduction thereof, in part or total, must be authorized by Tendencias Cerámicas, S.L. Otherwise, this action can be sanctioned according to the Law.

©2023 Tendencias Cerámicas

WOW, marca registrada por Tendencias Cerámicas, S.L.

La utilización de la marca o la reproducción del contenido de este catálogo está protegida por la Ley de Propiedad Intelectual. Cualquier uso de la marca o la reproducción del mismo, en parte o en su totalidad, debe ser autorizada por Tendencias Cerámicas, S.L., pudiendo, en caso contrario, ser esta acción sancionada de acuerdo con la Ley.

WOW reserves the right to modify and/or discontinue certain models displayed in this catalogue.
The colour of the pieces displayed herein may differ slightly from originals.
The settings shown in this catalogue are design proposals for advertising purposes.
In real situations in which the pieces are laid, the installation instructions published by WOW should be followed.

WOW se reserva el derecho de modificar y/o suprimir ciertos modelos expuestos en este catálogo sin previo aviso.
Los colores de las piezas pueden presentar ligeras diferencias respecto a las originales.
Los ambientes que se muestran en este catálogo son sugerencias decorativas de carácter publicitario,
debiéndose utilizar en la instalación real las instrucciones de colocación editadas por WOW.





WOW

www.wowdesigneu.com