

9CENTO

Tales from the Villas



Our values/

Made in Italy

Selezioniamo le migliori materie prime e, secondo canoni estetici e funzionali, le trasformiamo in prodotti che interpretano con creatività il gusto italiano. Utilizziamo in uguale misura passione e tecnologia, cura del dettaglio e precisione, chimica e cultura, estetica e attenzione all'ambiente. Per noi Made in Italy è racchiudere tutto questo in ogni singolo prodotto.

Made in Italy

We pick the very best raw materials and we follow aesthetics and functional criteria to turn them into products embodying Italian taste and excellence. We sharply combine passion and technology, creativity and accuracy, science and culture, and environmental friendliness. To all of us, Made in Italy means gathering these features into every single product.

Greenthinking

Recuperiamo il 100% dell'acqua, autoproduciamo il 65% dell'energia, differenziamo il 98% dei rifiuti. Siamo stati i primi del settore ceramico a ottenere la certificazione PEF e tra i primi a guadagnarci l'EPD, la FDES e la HPDC. La maggior parte dei nostri prodotti è compatibile con lo standard LEED - Leadership in Energy and Environmental Design. Questo per noi è Greenthinking: un promessa molto seria, un impegno quotidiano.

Greenthinking

We recycle 100% of our water, produce 65% of our energy, separate 98% of our waste. We were the first company in the ceramic industry to obtain PEF certification and were among the first to earn the EPD, the FDES, and the HPDC certifications. The majority of our products comply with the LEED - Leadership in Energy and Environmental Design - standard. Greenthinking implies a solemn promise, an everyday commitment.

GRES PORCELLANATO
PORCELAIN STONEWARE

Effetto marmo
Marble effect

9CENTO

Tales from the Villas



ISPIRAZIONE/ INSPIRATION

Tales from the Villas

Le *domus* del Novecento sono come grandi farfalle posate delicatamente al suolo: mostrano un'architettura monumentale e, al tempo stesso, leggerissima. Così Gio Ponti, maestro del ventesimo secolo, vedeva la sua Villa Planchart, a Caracas: vivace, armoniosa, uno scrigno di decorazioni ricche e multiformi. Tra scorci interni e aperture panoramiche, appaiono soffitti e pareti variopinte, pavimenti ricoperti di marmi incantevoli e palladiane dalle geometrie preziose, da cui è difficile staccare lo sguardo.

Tales from the Villas

The domus of the 1900s are like giant butterflies resting gently on the ground, revealing a monumental yet incredibly light architecture. This is how 20th century designer Gio Ponti saw Villa Planchart, his home in Caracas: a harmonious plethora of rich and varied decorations overflowing with life. As you take in the interiors and panoramic expanses, the multicoloured walls and ceilings that appear, along with superb marble floors featuring exclusive geometries in the Palladian style, make it almost impossible to look away.



INDOOR

- 120x278 6 mm
- 120x120 9 mm
- 60x120 9 mm
- 30x120 9 mm
- 60x60 9 mm

5 FORMATI/ SIZES

2 SPESSORI/ THICKNESSES

Formati e spessori

Ricerca espressiva e raffinatezza tecnica si incontrano, ancora una volta, nelle cinque misure di 9Cento - tutte di lato 120 cm, ad eccezione del formato minimo, il quadrato 60x60 cm. La grande lastra in 6mm, sintesi di resistenza tecnica e di eccellenza estetica, offre una dimensione privilegiata per godere delle trame imprevedibili e ricchissime delle superfici in marmo ceramico.

Sizes and thicknesses

Expressive research and technical finesse are reunited in all five sizes of 9Cento - all of which measure 120 cm along the side, with the exception of the smallest size, the 60x60 cm square. The large tile, in a thickness of 6 mm, combines technical strength and aesthetic superiority in a size which beautifully presents the rich and unpredictable textures of the ceramic marble surfaces.



6 COLORI/ COLORS

1 SUPERFICIE/ SURFACE

Colori e superfici

Il carattere di 9cento è forte, la vocazione chiara: accendere, elevare, trasformare. Nelle geometrie palladiane e nei cinque colori si legge l'indole esuberante dei maestri dell'architettura moderna. Sotto una perfetta finitura lappata, il rigore del design accoglie l'imprevedibilità dei segni naturali: tutto affiora dando un nuovo, seducente senso alla parola decorazione.

Colors and surfaces

9Cento has a strong personality and a clear vocation: to ignite, elevate and transform. The exuberant souls of the architects behind its creation are immediately visible in the Palladian geometries and five shades of colour. The rigorous design that lies beneath a perfectly smooth finish embraces the unpredictability of the marks left by nature. Everything emerges, suggesting a new and seductive interpretation of the word "decoration".



Metamorfofi



Ombra
Moca



Raggio
Verde



Alba Oro



Aurora
Beige



Riflesso
Bianco

metamorfosi

Trasformata dalla combinazione perfetta di colore, forma e lucentezza, la palladiana spicca un volo maestoso di fantasia e rigore. Appena si posa, diventa un pavimento-farfalla o un rivestimento di rara bellezza. Marmi a spicchi liberano geometrie inaspettate, quasi magnetiche; colori di carattere diverso, celebrano l'uso creativo di materiali naturali in contesti avveniristici. Con Metamorfosi, gli ambienti nuovi possono misurarsi con un secolo di architetture rivoluzionarie e, allo stesso tempo, lasciar viaggiare i progetti contemporanei verso confini decorativi che ancora non conosciamo / Transformed by the perfect combination of colour, shape and shine, the Palladian style takes flight on the wings of fantasy and rigour. As soon as it lands, it becomes a butterfly floor, a covering of rare beauty. Sections of marble release unexpected, almost magnetic geometries; varying colours celebrate the creative use of natural materials in futuristic contexts. Metamorfosi makes it possible for new interiors to contend with a century of revolutionary architecture while allowing contemporary projects to journey towards decorative frontiers that we have yet to discover

60x120 (24"x48") -
RAGGIO VERDE 120x278 (48"x110") -
OMBRA MOCA 60x120 (24"x48")

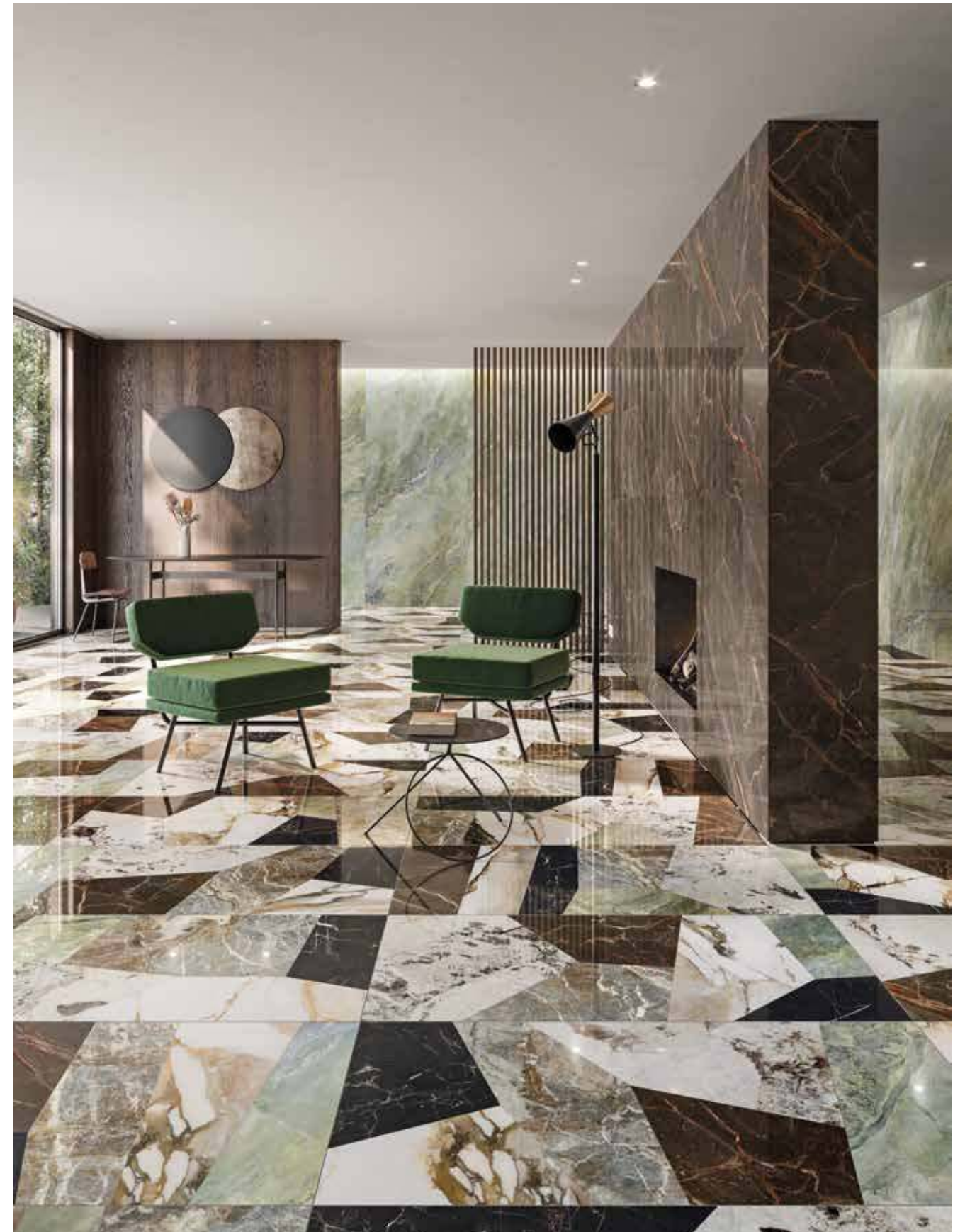

60x120 (24"x48")



9cento metamorfosi



60x120 (24"x48") -
OMBRA MOCA 60x120 (24"x48")

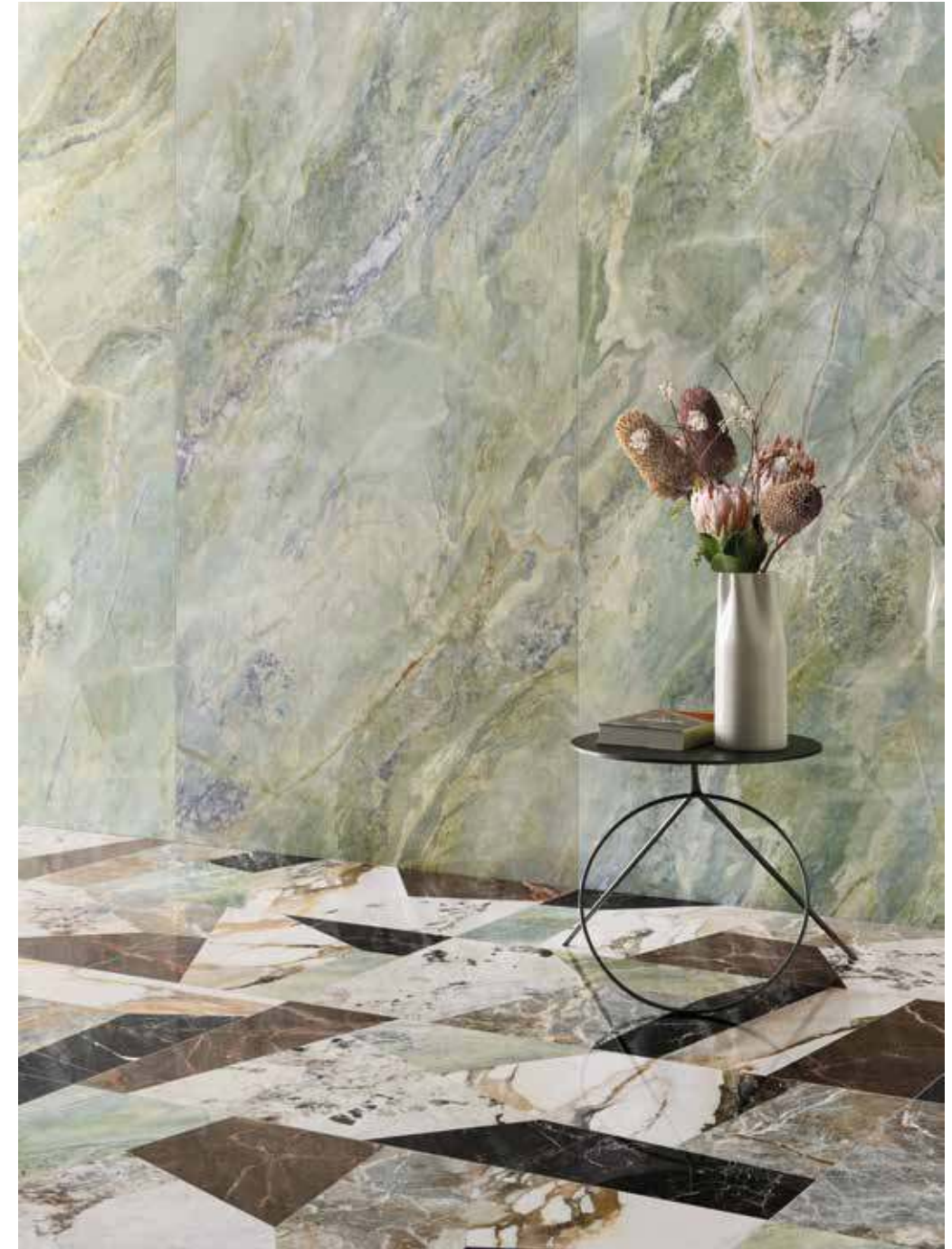

60x120 (24"x48") -
RAGGIO VERDE 120x278 (48"x110")

ombra moca

*Sul fondo, un cielo brunito, si consuma una tempesta di striature color tè o caffelatte, con punte sfumate di terracotta. Ogni grammo di pigmento scatena un dialogo intimo ma intenso con lo spazio /
A darkened sky in the background is lit up by a storm of streaks in shades of colour reminiscent of tea and coffee, tipped with touches of terracotta. Every gram of pigment triggers an intimate yet intense exchange with space*

120x120 (48"x48") -

REALIZZATI SU MISURA / CUSTOM MADE TRIMS

CORNICE A L 15x5 (57/8"x1 15/16")

ZOCCOLO A L 15x3 (57/8"x1 3/16")

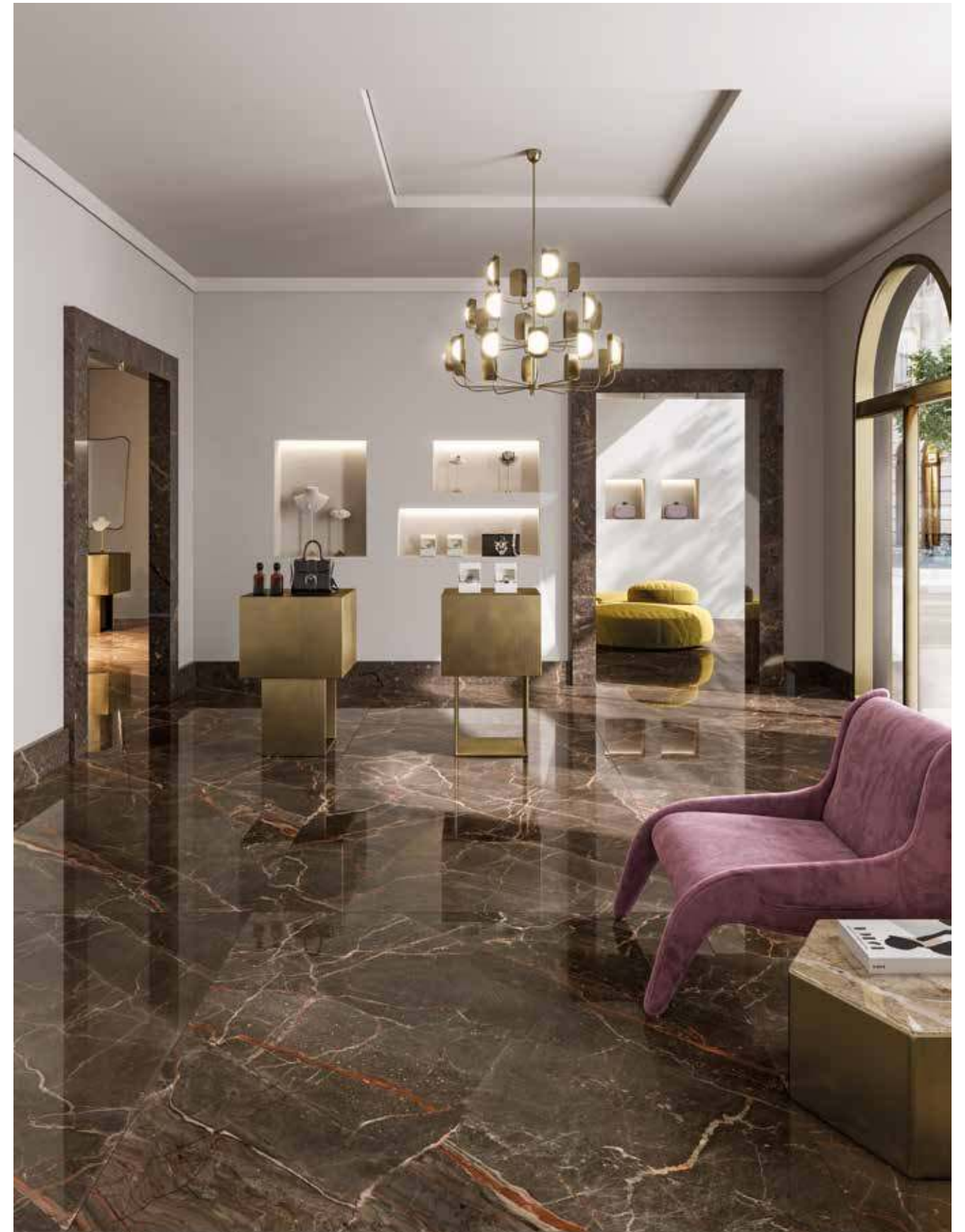



120x120 (48"x48")

REALIZZATI SU MISURA / CUSTOM MADE TRIMS

CORNICE A L 15x5 (5⁷/₈"x1¹⁵/₁₆")

ZOCCOLO A L 15x3 (5⁷/₈"x1³/₁₆")



120x120 (48"x48")

REALIZZATO SU MISURA / CUSTOM MADE TRIMS

ZOCCOLO A L 15x3 (5⁷/₈"x1³/₁₆")



120x120 (48"x48")

9cento ombra moca

raggio verde

*Brillante come i prati d'Irlanda, mutante come i cieli nordici: impossibile contare gli infiniti toni di verde che si fanno avanti in superficie, tra vene candide e filamenti minerali /
As bright as the Irish countryside, as uncertain as the Northern skies: there are so many different shades of green on the surface, streaked with candid veins and mineral filaments, that counting them is impossible*

120x278 (48"x110") - 120x120 (48"x48") -
MOSAICO PALM MIX 35x35 (13^{25/32}"x13^{25/32}"



120x120 (48"x48")

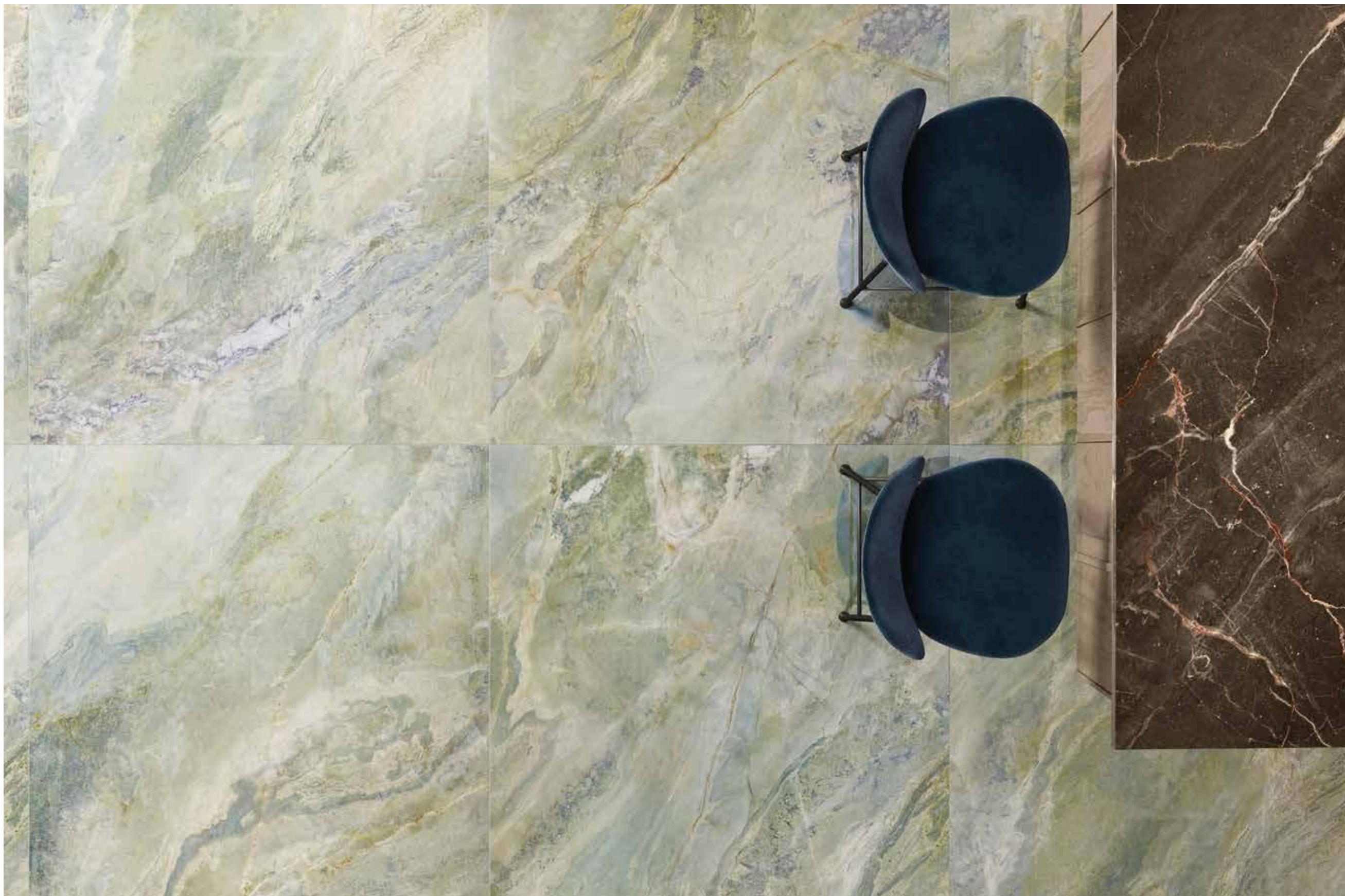

9cento raggio verde



MOSAICO PALM MIX
35x35 (13^{25/32}"x13^{25/32}"

alba oro

Il calacatta italiano è romantico, intriso di memorie antiche. Le venature, esili o corpose, si diramano come infiltrazioni dorate con pigmenti cipria o arancio, in un percorso scenografico sempre diverso / Italian Calacatta is a particularly romantic type of marble, steeped in ancient memories. Its veins, sometimes fine and sometimes coarse, extend like golden branches tinged with powder pink or orange pigments, in a pattern that never repeats itself

60x120 (24"x48") - 60x60 (24"x24") -

ELEMENTS DESIGN TAUPE
PIATTO DOCCIA FILO PAVIMENTO / SHOWER TRAY FLOOR LEVEL
HOME DECOR 80x120 (32"x48")
LAVELLO A COLONNA / COLUMN SINK
HOME DECOR 50x50x85 (20"x20"x33³/₈")

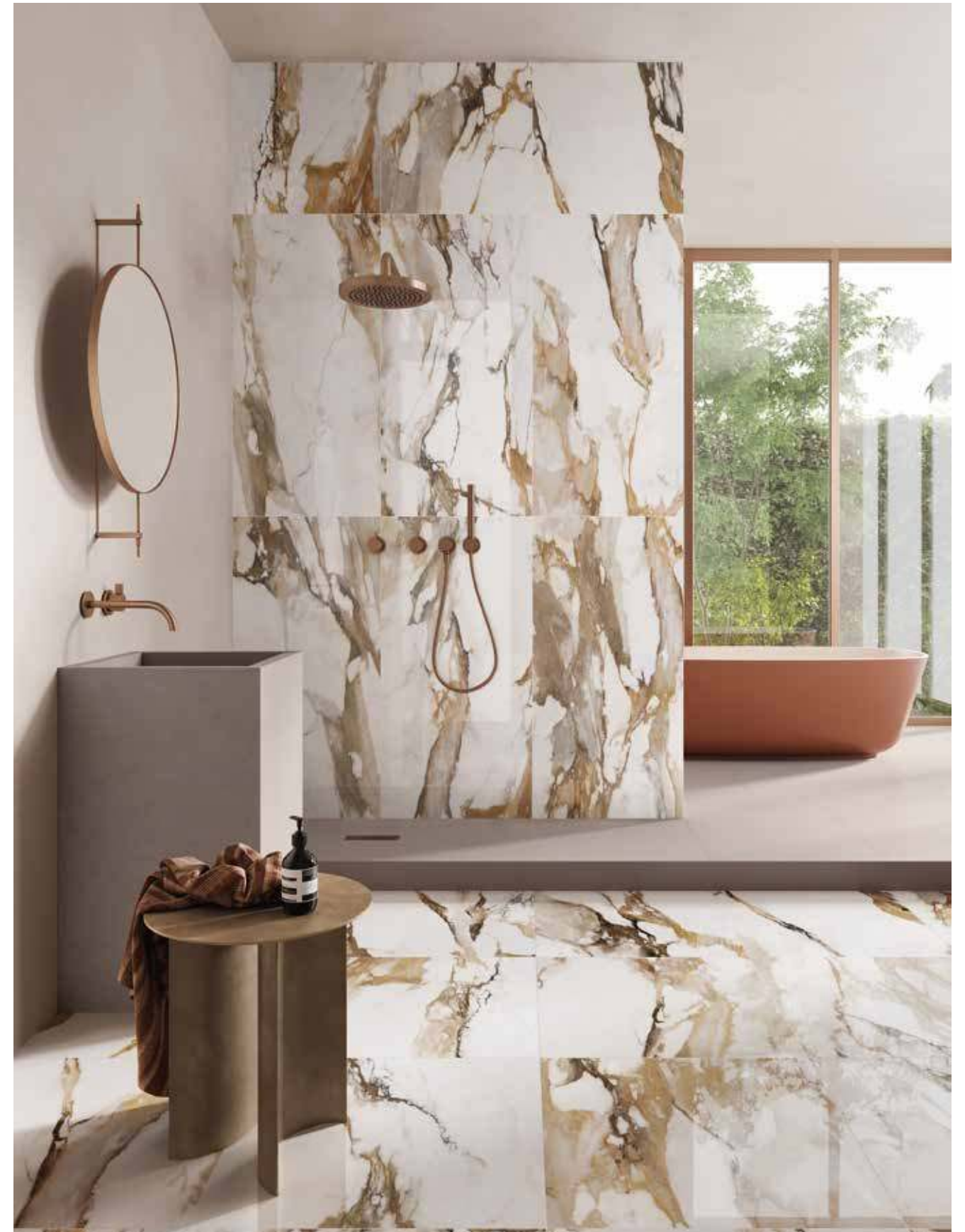



60x120 (24"x48")



60x60 (24"x24")

9cento alba oro

60x60 (24"x24") -

ELEMENTS DESIGN TAUPE
PIATTO DOCCIA FILO PAVIMENTO /
SHOWER TRAY FLOOR LEVEL
HOME DECOR 80x120 (32"x48") -
LAVELLO A COLONNA / COLUMN SINK
HOME DECOR 50x50x85 (20"x20"x33³/₈")



aurora beige

Quando i minerali si combinano fra loro a regola d'arte, il marmo brecciato si tinge delle prime luci del giorno. Dal fondo sale un beige morbido dalle sfumature variegata, tipico di una bellezza classica dall'anima mediterranea /

When minerals come perfectly together, Breccia marble reflects all the colours of the dawn sky. A soft, variegated beige emerges from the background, revealing all the classical beauty of its Mediterranean soul

120x278 (48"x110") - 120x120 (48"x48") -

REALIZZATI SU MISURA / CUSTOM MADE TRIMS

CORNICE A L 15x5 (57/8"x1 15/16")

ZOCCOLO A L 15x3 (57/8"x1 3/16")



120x278 (48"x110") -
REALIZZATO SU MISURA /
CUSTOM MADE TRIMS
ZOCOLO A L 15x3 (5^{7/8}"x1^{3/16}")



9cento aurora beige



120x120 (48"x48")

9cento aurora beige

riflesso bianco

*Un modello di eleganza esotica dal fondo luminoso ed evanescente su cui si aprono scaglie di origine granitiche. Scorrono rivoli di colore, pigmenti scuri si addensano e distanziano /
Exotic elegance with a bright and evanescent background flecked with scales of granitic origin.
Streams of colour run across the surface, dark pigments moving closer together and then further apart*

120x120 (48"x48")





120x120 (48"x48")



120x120 (48"x48")

120x120 (48"x48")



9cento riflesso bianco

HOME DECOR



LAVELLO A COLONNA
COLUMN SINK



DISPONIBILE IN / AVAILABLE IN
50x50x85 cm

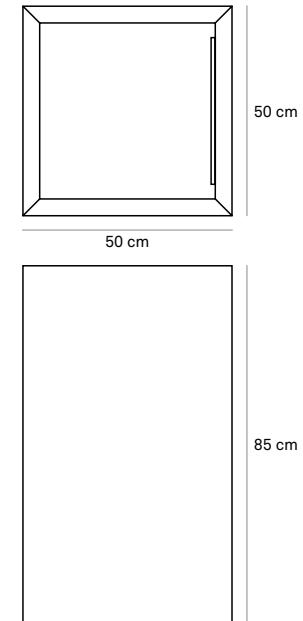

LAVELLO DA APPOGGIO
COUNTERTOP SINK



DISPONIBILE IN / AVAILABLE IN
35x50x12 cm

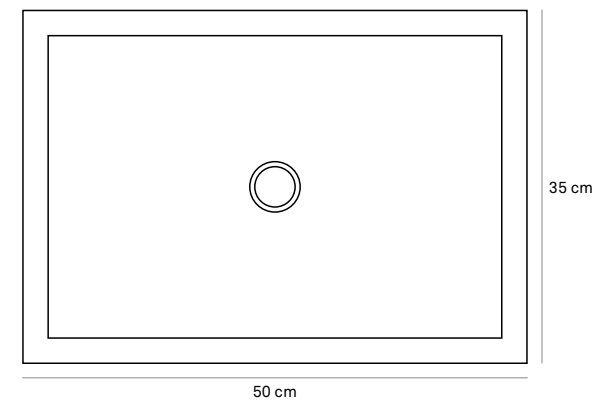

DISPONIBILE IN / AVAILABLE IN
50x120x12 cm
50x160x12 cm

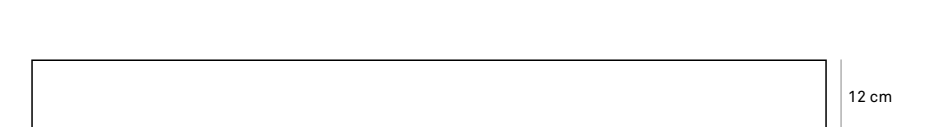
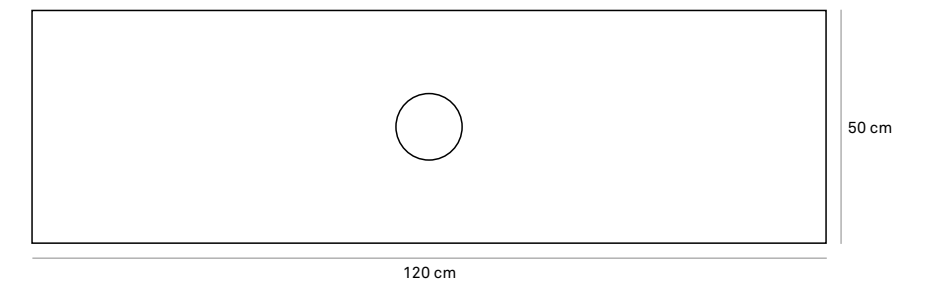

HOME DECOR



PIATTO DOCCIA*
SHOWER TRAY



DISPONIBILE IN / AVAILABLE IN

80x120 cm
80x135 cm
90x135 cm
90x160 cm

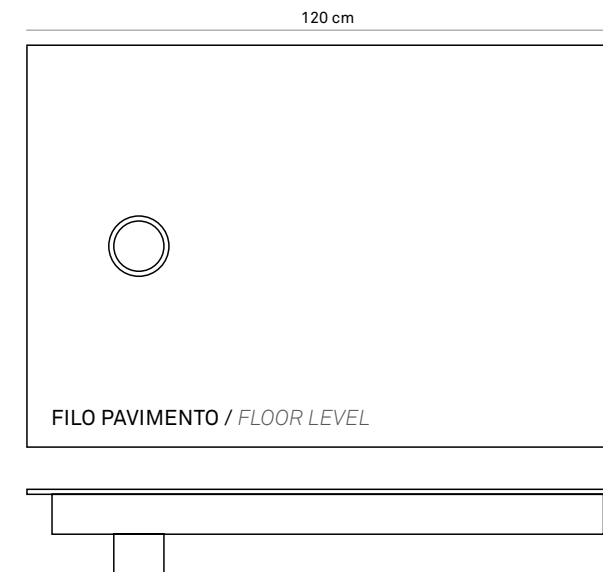

DISPONIBILE IN / AVAILABLE IN

80x120x4 cm
80x135x4 cm
90x135x4 cm
90x160x4 cm

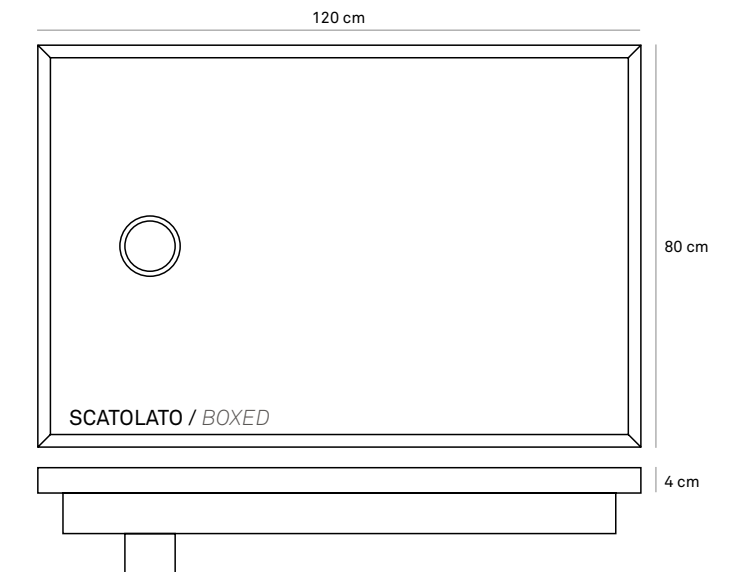

TAVOLINO CIRCOLARE
CIRCULAR TABLE



DISPONIBILE IN / AVAILABLE IN

Ø 42 cm H 50 cm
Ø 58 cm H 50 cm
Ø 73 cm H 39 cm

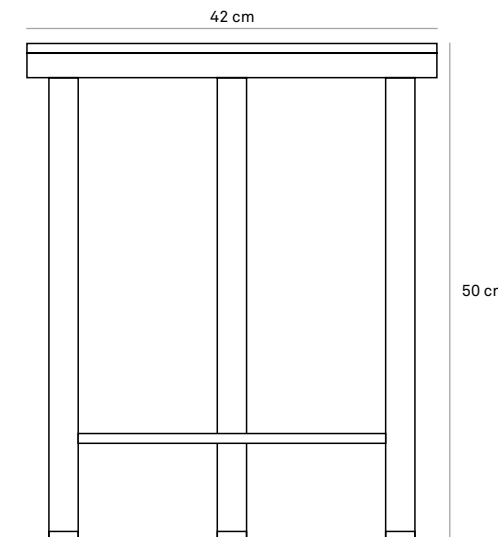

IT_

***Attenzione.** Per ottenere una superficie antiscivolo nel piatto doccia è necessario stendere un tappeto idoneo ad assicurare una presa sicura del piede in presenza di acqua.

EN_

***Warning.** To obtain a non-slip surface in the shower tray it is necessary to lay down a carpet suitable to ensure a secure grip of the foot in the presence of water.

HOME DECOR



TAVOLO RETTANGOLARE
RECTANGULAR TABLE



DISPONIBILE IN / AVAILABLE IN
95x200x75 cm



DISPONIBILE IN / AVAILABLE IN
95x175x75 cm

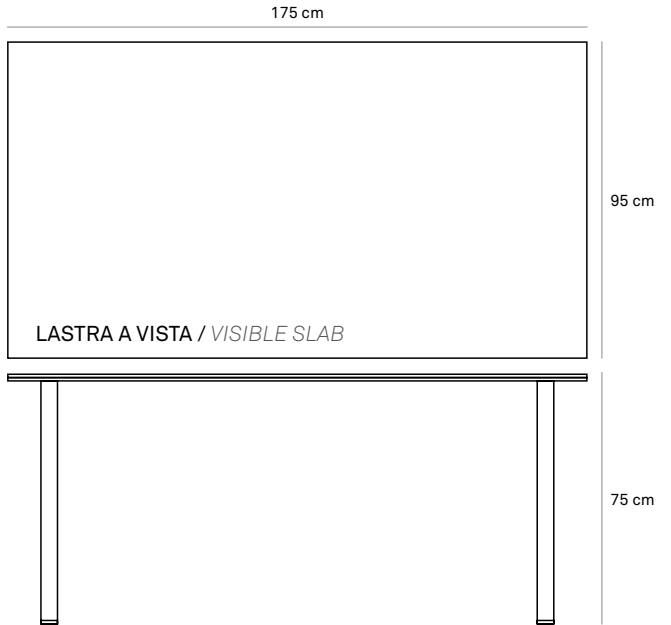

TAVOLO PLUS ATELIER
PLUS ATELIER TABLE



PERSONALIZZABILE IN DIMENSIONE E COLORE / CUSTOMIZABLE IN SIZE AND COLOR

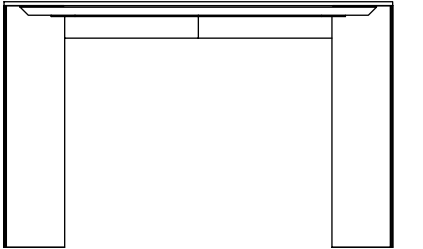
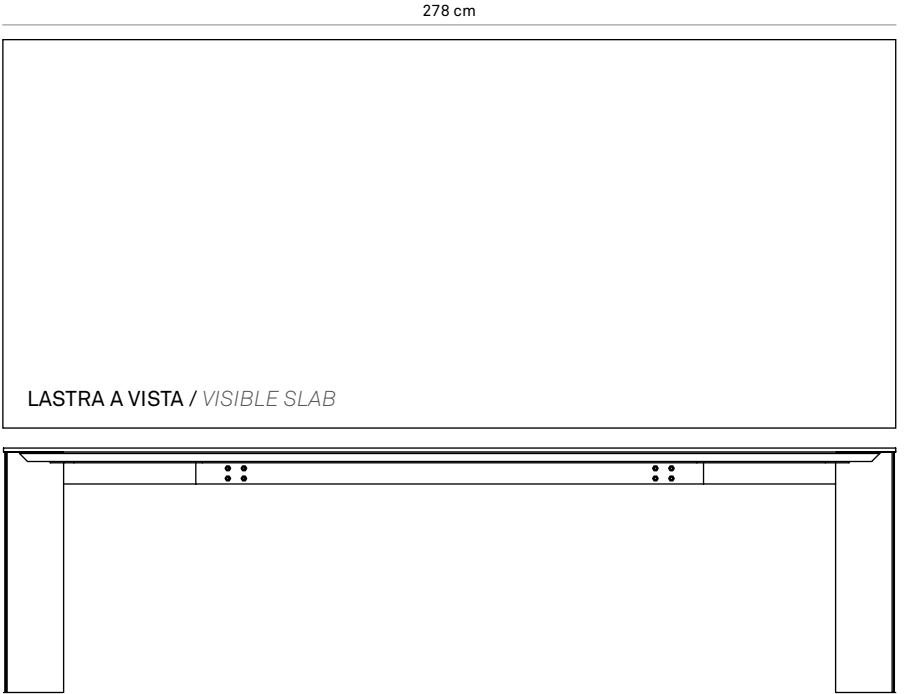

9CENTO

SPECIFICHE TECNICHE/ TECHNICAL FEATURES

GRES PORCELLANATO TUTTA MASSA GL
FULL-BODY PORCELAIN GL

SPESSORI
THICKNESSES

6 mm (120x278)

9 mm (120x120 - 60x120 - 30x120 - 60x60)

STONALIZZAZIONE
SHADING

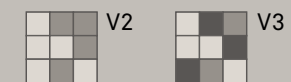

CLASSIFICAZIONE ANTISDRUCCIOLO
ASSESSMENT OF SLIP RESISTANCE

DIN 51130 Lappato

DIN 51097 Lappato

COF Conforme/*Compliant*

DCOF Conforme/*Compliant*

PENDULUM +36 PTV 96 (R10) -

GRES PORCELLANATO / PORCELAIN STONEWARE



INATTACCABILE DA ACIDI /
NOT ATTACKED BY ACIDS



FACILMENTE PULIBILE /
EASY TO CLEAN



ANTISDRUCCIOLO /
ANTI-SLIP

*per ambienti bagnati e outdoor /
for outdoor and wet environments*



NON REAGISCE AL FUOCO /
DOES NOT REACT TO FIRE

*non emette fumi in caso di incendio /
does not release fumes in case of fire*



RESISTENTE A GELO E SHOCK TERMICI /
RESISTANT TO FROST AND SUDDEN THERMAL CHANGES



RESISTENTE A SFORZI ED ABRASIONI /
RESISTANT TO STRESSES AND ABRASION

*500 Kg/cm² di pressatura meccanica e cottura a 1.250°C /
500 kg/cm² of mechanical pressing and firing at 1250°C*



STABILE CROMATICAMENTE /
CHROMATICALLY FAST

*inalterabile da agenti atmosferici e smog /
unchanged by weather agents and smog*



ASSORBIMENTO H₂O NULLO /
NULL H₂O ABSORPTION

GREENTHINKING / GREENTHINKING



100% ACQUE REFLUE RECUPERATE /
100% RECOVERED WASTE WATER



**98% RIFIUTI AVVIATI A
RACCOLTA DIFFERENZIATA /**
98% WASTE SENT TO SEPARATE COLLECTION



100% PALLET FAO /
100% FAO PALLETS



100% SCARTI CRUDI RECUPERATI /
100% RECOVERED RAW SCRAPS



**ENERGIA AUTO-PRODOTTA DA
FOTOVOLTAICO /**
ENERGY SELF-PRODUCED BY PV PLANT



*** + 5.000.000 L = 3.000.000** 
**ACQUE DI PROCESSO DA ALTRI
STABILIMENTI /**
PROCESS WATER FROM OTHER FACTORIES



*** 18.408 t = 570** 

**MATERIE PRIME NON ESTRATTE
GRAZIE AL RECUPERO DI SCARTI /**
*NON-EXTRACTED RAW MATERIALS THANKS TO THE
RECOVERY OF SCRAPS*



*** + 24.000 MWh/year = 185.000** 
**84% ENERGIA AUTO PRODOTTA DA IMPIANTI
DI COGENERAZIONE /**
84% ENERGY SELF-PRODUCED BY COGENERATION PLANTS

METAMORFOSI



OMBRA MOCA



RAGGIO VERDE



ALBA ORO



AURORA BEIGE



RIFLESSO BIANCO



V2 V3

STONALIZZAZIONE/
SHADING

METAMORFOSI **V3**



OMBRA MOCA **V2**



RAGGIO VERDE **V2**



specs & tech

V2
STONALIZZAZIONE/
SHADING

ALBA ORO V2



AURORA BEIGE V2



RIFLESSO BIANCO V2



5

FORMATI/
SIZES

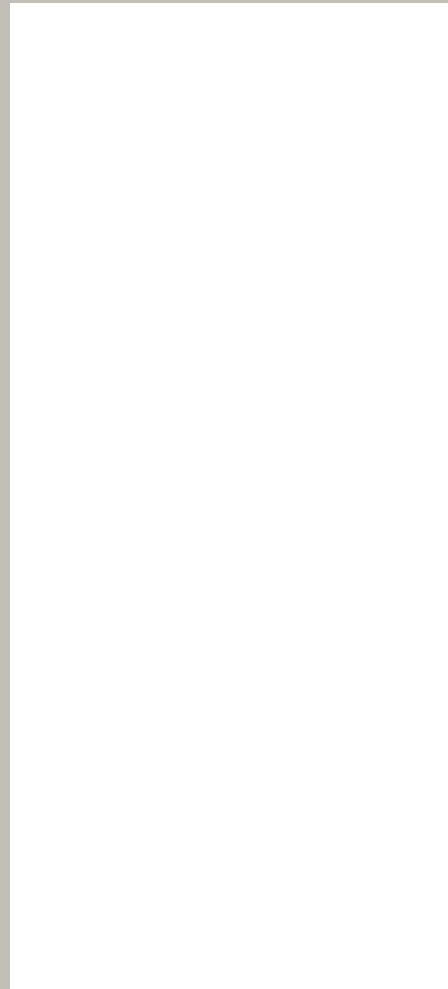

◆ 120x278 (48"x110") RT 6 mm

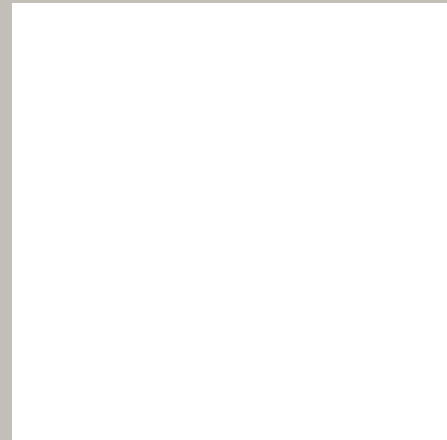

◆ 120x120 (48"x48") RT 9 mm

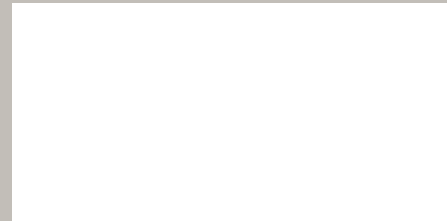

◆ 60x120 (24"x48") RT 9 mm



◆ 30x120 (12"x48") RT 9 mm

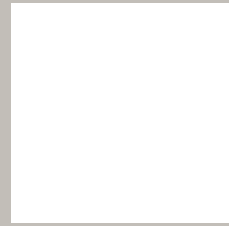

◆ 60x60 (24"x24") RT 9 mm

◆ Lappato

2

DECORI/
DECORS

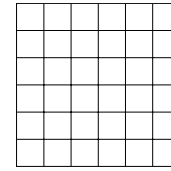

MOSAICO ◆ 30x30 (12"x12") RT 9 mm
(TESSERE: 4,8x4,8 (1 7/8"x1 7/8"))



OMBRA MOCA



RAGGIO VERDE



ALBA ORO



AURORA BEIGE



RIFLESSO BIANCO

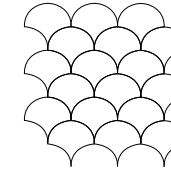

MOSAICO PALM MIX ◆ 35x35 (13 25/32"x13 25/32") RT 9 mm
(TESSERE: 10x10 (3 15/16"x3 15/16"))



PALM MIX
(RIFLESSO BIANCO-OMBRA MOCA-RAGGIO VERDE)

6

PEZZI SPECIALI/ TRIMS



BATTISCOPA

- ◆ 4,6x120 (1^{13/16}"x48") RT 9 mm
- ◆ 7,2x60 (2,8"x24") RT 9 mm

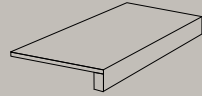

SCALINO INCOLLATO

- ◆ 33x60 (13"x24") RT 9 mm



ANGOLARE INCOLLATO

- ◆ 33x33 (13"x13") RT 9 mm

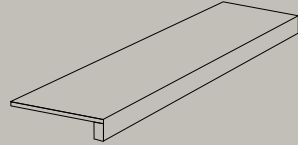

SCALINO INCOLLATO

- ◆ 33x120 (13"x48") RT 9 mm

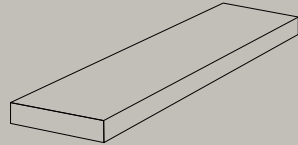

ANGOLARE INCOLLATO

- ◆ 33x120 (13"x48") RT 9 mm

◆ Lappato

SCHEMI DI POSA/ LAYING SYSTEM

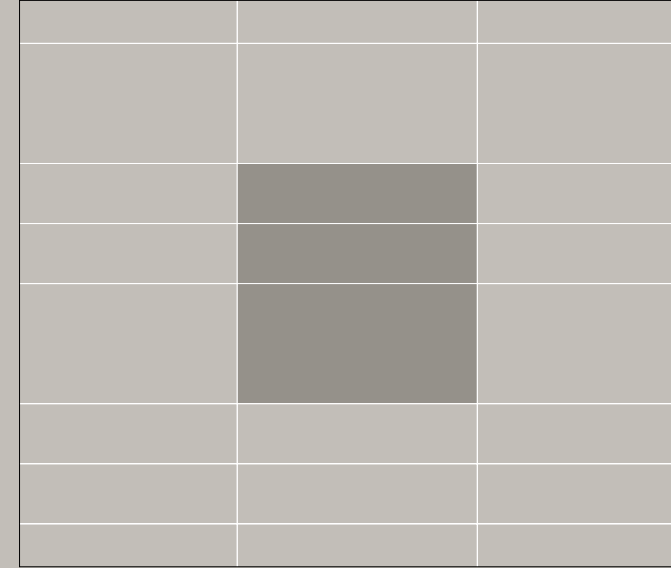

30x120 (12"x48") RT - 50,00%
60x120 (24"x48") RT - 50,00%

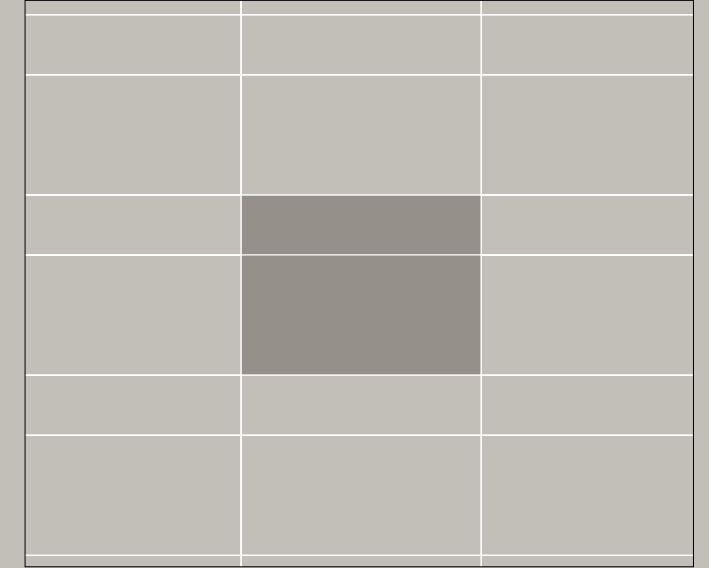

30x120 (12"x48") RT - 33,33%
60x120 (24"x48") RT - 66,66%

Fuga minima consigliata per posa in interno 2 mm
Minimum suggested joint for indoor laying 2 mm
Consigli di posa, pulizia e manutenzione al link keope.com
Advice on laying, cleaning and maintenance at the link keope.com

1
FINITURA/
FINISH



FORMATI / SIZES

	120x278 (119,5x278)* 48"x110"	120x120 (119,5x119,5)* 48"x48"	60x120 24"x48"	30x120 12"x48"	60x60 24"x24"
working size	1194x2778	1194x1194	596x1195	297x1195	596x596
	RT	RT	RT	RT	RT
	6 mm	9 mm	9 mm	9 mm	9 mm
AURORA BEIGE	◆	◆	◆	◆	◆
RAGGIO VERDE	◆	◆	◆	◆	◆
OMBRA MOCA		◆	◆	◆	◆
ALBA ORO		◆	◆	◆	◆
RIFLESSO BIANCO		◆	◆	◆	◆
METAMORFOSI			◆		









*Formato nominale / Nominal size

◆ Lappato

MISURE, PESI ED IMBALLI / SIZE, WEIGHT AND PACKAGING

FORMATO SIZE	SPESSORE THICKNESS	PZ/SCATOLA PIECES/BOX	MQ/SCATOLA SQM/BOX	KG/SCATOLA KG/BOX	MQ/PALLET SQM/PALLET	KG/PALLET KG/PALLET	SCATOLA/PALLET BOX/PALLET
120x278	6 mm	1	3,32	49,37	59,80	988,66	18
120x120	9 mm	2	2,86	60,80	57,12	1.229,00	20
60x120	9 mm	2	1,44	31,93	50,40	1.130,55	35
30x120	9 mm	4	1,44	31,48	51,84	1.146,28	36
60x60	9 mm	3	1,08	25,00	43,20	1.013,00	40

INFORMAZIONI TECNICHE / TECHNICAL FEATURES

INFORMAZIONI TECNICHE TECHNICAL FEATURES	NORMA NORM EN 14411 - ISO 13006	REQUISITI PRESCRITTI REQUIRED VALUES	VALORI VALUES
 DIMENSIONI RETTIFICATO SIZES RECTIFIED	UNI EN ISO 10545-2	lunghezza-larghezza / length-width $\pm 0,3\%$ ($\pm 1,0$ mm max) spessore / thickness $\pm 5,0\%$ ($\pm 0,5$ mm max) ortogonalità / rectangularity $\pm 0,3\%$ ($\pm 1,5$ mm max) rettilinearità / straightness $\pm 0,3\%$ ($\pm 0,8$ mm max) planarità / flatness $\pm 0,4\%$ ($\pm 1,8$ mm max) qualità superficie / surface quality $\geq 95\%$	CONFORME COMPLIANT
 ASSORBIMENTO ACQUA WATER ABSORPTION	UNI EN ISO 10545-3	$\leq 0,5\%$	$\leq 0,1\%$
 RESISTENZA A ROTTURA BREAKING STRENGTH	UNI EN ISO 10545-4	$R \geq 35$ N/mm ² $S \geq 700$ N (<7,5 mm) $S \geq 1300$ N ($\geq 7,5$ mm)	6 mm CONFORME COMPLIANT 9 mm CONFORME COMPLIANT
 RES. ABRASIONE SUPERFICIALE (GL - Lappato) SURFACE ABRASION RESISTANCE (GL - Lappato)	UNI EN ISO 10545-6	dichiarare un valore / declare a value	TEST DISPONIBILE TEST AVAILABLE
 RESISTENZA SHOCK TERMICI THERMAL SHOCK RESISTANCE	UNI EN ISO 10545-9	resistenza / resistant	CONFORME COMPLIANT
 RESISTENZA AL GELO FROST RESISTANCE	UNI EN ISO 10545-12	resistenza / resistant	CONFORME COMPLIANT
 RESISTENZA CHIMICA CHEMICAL RESISTANCE	UNI EN ISO 10545-13	resistenza / resistant	CONFORME COMPLIANT
 RESISTENZA ALLE MACCHIE RESISTANCE TO STAINS	UNI EN ISO 10545-14	pulibile / cleanable	CONFORME COMPLIANT
	DIN 51130	R	prodotto / product R A+B+C >0,40 >0,42
	DIN 51097	A+B+C	
 CLASSIFICAZIONE ALTISDRUCCIOLO ASSESSMENT OF SLIP RESISTANCE	B.C.R.A. (COF)	>0,40 bagnato / wet	120x278 Lappato - 120x120 Lappato - 60x120 Lappato - 30x120 Lappato - 60x60 Lappato - - -
	ANSI A137.1 2012 (DCOF)	>0,42 bagnato / wet	
	Pendulum Test Value PTV 96 (R10)	> 36	-

Piastrelle pressate a secco - Conforme alla norma EN 14411 e ISO 13006 appendice G gruppo B1-a con E $\leq 0,5\%$
Dry pressed tiles - Compliant with standards EN 14411 and ISO 13006 annex G group B1-a with E $\leq 0,5\%$



HEADQUARTER via statale 467, 21
42013 Casalgrande (RE) - Italy
FACTORY via canale, 67
42013 Casalgrande (RE) - Italy
WAREHOUSE via dell'industria, 1
42013 Casalgrande (RE) - Italy

PHONE +39 0522 997511
FAX +39 0522 997544 (OT) - 545 (IT)
ADMIN. FAX +39 0522 997413

info@keope.com
keope.com

IT_
Ceramiche Keope si riserva la facoltà di apportare variazioni ai prodotti illustrati in questo catalogo per necessità produttive o al fine di migliorarne la qualità. I campioni e le immagini sono puramente indicativi. Gli imballaggi e pesi riportati possono variare per necessità produttive. Consultare gli uffici commerciali al momento dell'ordine.

EN_
Ceramiche Keope reserves the right to vary the products illustrated in this catalogue for production purposes or in order to improve quality. Samples and images are purely indicative. Packaging and weights shown may be varied in line with production requirements. Check with the sales department at the time of order.

