

PROVOAK

PROVENZA



PROV**OAK**





Oak wood and its compact vein patterns are the basis for a strikingly natural, beautiful, varied collection. The different ways in which oak can be finished provide the inspiration for the Provoak style, exceptionally versatile and therefore the ideal choice for various taste categories, from the most classical to the trendy, and for the flawless construction of tailored design schemes.

L'essenza del rovere e le venature compatte della quercia danno vita ad una collezione che colpisce per naturalezza, fascino e varietà. Sono proprio le differenti lavorazioni del rovere ad ispirare lo stile di **PROVOAK**, la cui spiccata versatilità la rende una scelta ideale per soddisfare diverse aree di gusto, da quella di ispirazione più classica a quella di tendenza, e costruire perfetti ambienti su misura.



lavorazioni

Essenza nobile e selezionata con venature dalle linee senza interruzioni, eleganti ed armoniose per un prodotto rassicurante, dal gusto pulito e minimal.

La selezione di assi di quercia naturali di recupero conferisce agli ambienti il fascino dello scorrere del tempo e alle superfici una personalità di rilievo.

La lavorazione di spazzolatura rende la superficie morbida e setosa nei variegati toni del grigio, mettendo in evidenza le naturali venature del rovere.

La lavorazione di sabbatura sbianca il legno mettendo in risalto le venature ed esaltando tridimensionalità alle superfici. Perfetta per creare splendidi ambienti contemporanei.

L'effetto della bruciatura ottenuta dalla fiamma del fuoco conferisce una particolare tonalità scura che esalta l'eleganza delle superfici conferendo grande eleganza agli ambienti.

Il Graven propone una superficie decorativa che riproduce la tecnica della cesellatura. I segni di questa lavorazione artigianale diventano elementi di decoro variegati che esaltano la tridimensionalità del prodotto. Disponibile in ogni colore della collezione Provoak.

Il Woodcut presenta sulla superficie una sequenza di incisioni ispirate alla lavorazione con sega circolare. I segni sulla superficie sono di diversa profondità e lunghezza e conferiscono tridimensionalità al prodotto, rendendolo ideale come elemento d'arredo per pareti di stile. E' disponibile in ogni colore della collezione Provoak.

ROVERE PURO

QUERCIA RECUPERATA

GRIGIO SPAZZOLATO

BIANCO SABBATO

NERO BRUCIATO

GRAVEN

WOODCUT

ROVERE PURO

A choice, exquisite timber with elegant, attractive unbroken vein patterns for a product with a reassuring mood in simple, minimalist taste.

QUERCIA RECUPERATA

Selected salvaged natural oak planks enrich design schemes with a time-worn beauty and give surfaces an impressive personality.

GRIGIO SPAZZOLATO

Brushing leaves the surface soft and silky, in variegated shades of grey, highlighting the oak's natural vein patterns.

BIANCO SABBATO

The sanding process bleaches the wood and emphasises its vein patterns, giving a more three-dimensional effect. Perfect for creating splendid contemporary design schemes.

NERO BRUCIATO

The effect of burning with a naked flame gives the oak a particularly dark colour for an even more elegant surface, creating exquisite interiors.

GRAVEN

Graven has a decorated surface that imitates chiselling. The marks created by this hand-carving technique are transformed into variegated decorative motifs that underline the product's three-dimensional beauty. Available in all Provoak collection colours.

WOODCUT

The surface of Woodcut features a series of scored cuts resembling those made by a circular saw. The marks on the surface vary in depth and length and give the product three-dimensional substance, making it an ideal ornamental, stylish wall covering. Available in all Provoak collection colours.



PROVOAK



55PV0R - Bianco Sabbiato Nat. Rett. 30x120 - 11^{13/16}x47^{1/4}"

54PV0R - Bianco Sabbiato Nat. Rett. 20x120 - 7^{7/8}x47^{1/4}"

BIANCO SABBIATO





54PVORZ - Bianco Sabbiato Nat. Rett. - 20x120 - 7¹⁸/₁₆ x 47¹⁴/₁₆

AntiSlip



QUERCIA RECUPERATA



28PV3R - Quercia Recuperata Nat. Rett. - 20x180 - 7^{7/8}"x70^{7/8}" **54PV3R** - Quercia Recuperata Nat. Rett. - 26,5x180 - 10^{7/16}"x70^{7/8}"
H30PV3 - Chevron Mono Quercia Recuperata - 29,4x34 - 11^{9/16}"x13^{3/8}" **54PV9R** - Nero Bruciato Nat. Rett. - 20x120 - 7^{7/8}"x47^{1/4}"
54PV9RB - Woodcut Nero Bruciato Nat. Rett. - 20x120 - 7^{7/8}"x47^{1/4}"



WOODCUT





M30PV3 - Sestino Quercia Recuperata - 30x30 - 11^{13/16} x 11^{13/16}
54PV0R - Bianco Sabbiato Nat. Rett. - 20x120 - 7^{7/8} x 47^{1/4}
54PV0RB - Woodcut Bianco Sabbiato Nat. Rett. - 20x120 - 7^{7/8} x 47^{1/4}



54PV8R - Grigio Spazzolato Nat. Rett. - 20x120 - 7^{7/8}x47^{1/4}"

GRIGIO SPAZZOLATO



28PV8R - Grigio Spazzolato Nat. Rett. - 20x180 - 7^{7/8}x70^{7/8}
27PV8R - Grigio Spazzolato Nat. Rett. - 26,5x180 - 7^{7/16}x70^{7/8}
54PV8RC - Graven Grigio Spazzolato Nat. Rett. - 20x120 - 7^{7/8}x47^{1/4}



28PV9R - Nero Bruciato Nat. Rett. - 20x180 - 7^{1/8}x70^{7/8}



NERO BRUCIATO



H30PV9 - Chevron Mono Nero Bruciato Nat. Rett. - 29,4x34 - 11⁹/₁₆"x13³/₈"
54PV9RB - Woodcut Nero Bruciato Nat. Rett. - 20x120 - 7⁷/₈"x47¹/₄"





ROVERE PURO



28PV1R - Rovere Puro Nat. Rett - 20x180 - 7^{7/8} x 70^{7/8}



28PV1R - Rovere Puro Nat. Rett. - 20x180 - 7^{7/8} x 70^{7/8}
27PV1R - Rovere Puro Nat. Rett. - 26,5x180 - 7^{7/16} x 70^{7/8}

54PV1RC - Graven Rovere Puro Nat. Rett. - 20x120 - 7^{7/8} x 47^{1/4}
H30PV13 - Chevron Multi Rovere/Quercia/Bianco - 29,4x34 - 11^{9/16} x 13^{3/8}



GRAVEN

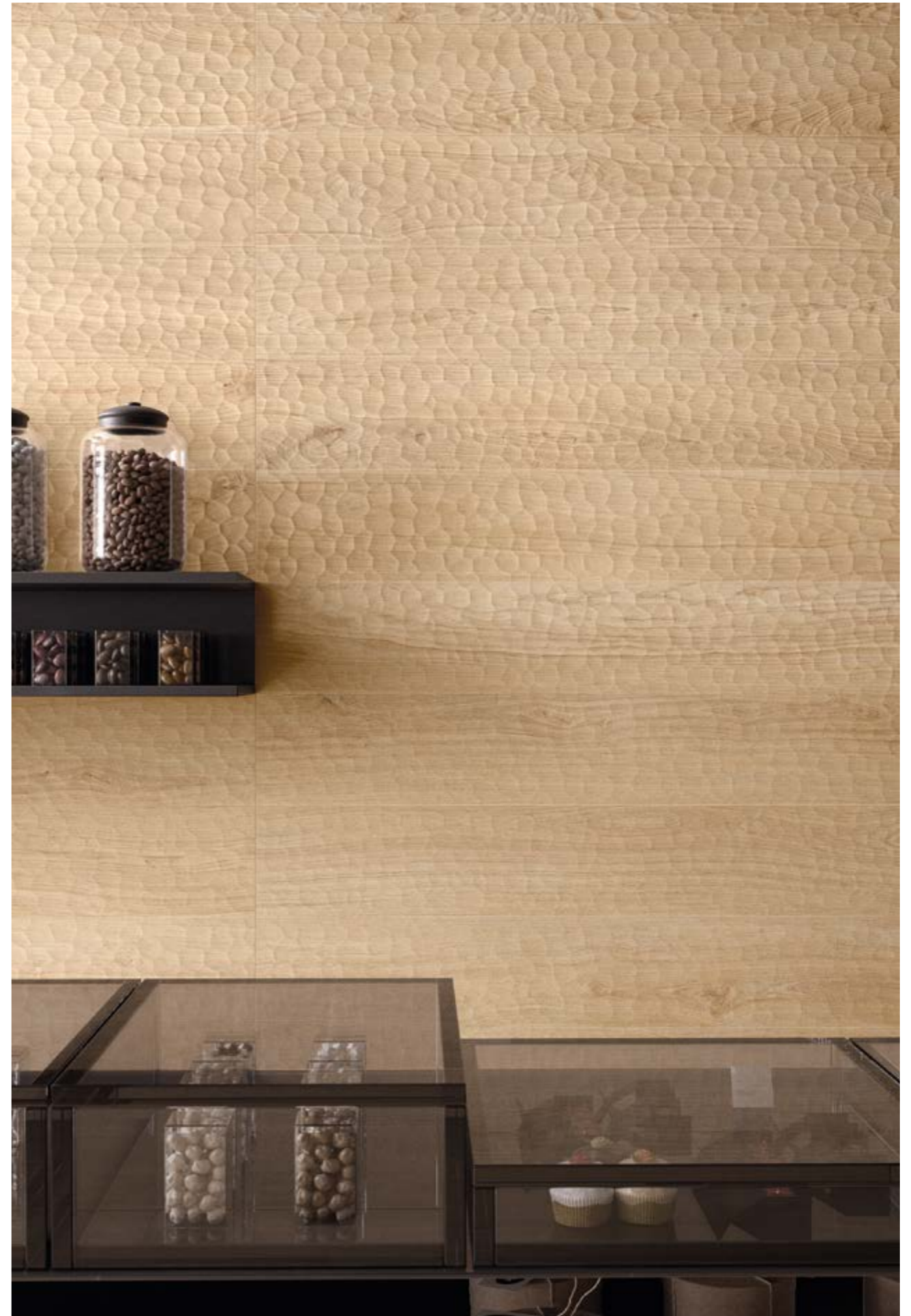

20MM

40x120

Provoak 20mm offre la possibilità di realizzare spazi esterni di grande valore estetico, senza rinunciare alle prestazioni tecniche.

Le caratteristiche specifiche di **Provoak 20mm** permettono di integrare perfettamente il materiale con l'ambiente circostante, offrendo la possibilità di creare in modo semplice ed efficace camminamenti e percorsi outdoor.

L'alto spessore di **Provoak 20mm** garantisce un'elevata resistenza rendendolo ideale negli ambienti interni ed esterni pubblici.

Provoak 20mm è facile da posare su erba, su sabbia, su ghiaia. La posa a colla su massetto permette di realizzare pavimentazioni carrabili industriali e commerciali. Ideale per rampe di accesso e garage.

Provoak 20mm è l'ideale per la creazione di pavimenti sopraelevati.



X41PV8R - Grigio Spazzolato Nat. Rett. - 40x120 - 15^{3/4} x 47^{1/4} 20MM



20MM
40x120



Provoak 20mm offers the chance to develop extremely aesthetically pleasing external spaces without compromising on technical expertise.

The specific qualities of **Provoak 20mm** allow you to perfectly integrate the material in the surrounding environment, making it possible to create walkways and outdoor paths easily and effectively.

The thickness of **Provoak 20mm** guarantees excellent resistance, making it ideal for use in both indoor and outdoor public spaces.

Provoak 20mm is easy to lay on grass, sand and gravel. By gluing it down to screed it is possible to create industrial and commercial paved driveways. Ideal for access ramps and garages.

Provoak 20mm is ideal for the creation of cavity floors.



ROVERE PURO

QUERCIA RECUPERATA

GRIGIO SPAZZOLATO

BIANCO SABBBIATO

NERO BRUCIATO

FORMATI

SIZES / FORMATS / FORMATE /
TAMAÑOS / ФОРМАТЫ

26,5x180 - 10^{7/16} x 70^{7/8}"

27PV1R Rovere Puro Nat. Rett.	102
27PV3R Quercia Recuperata Nat. Rett.	102
27PV8R Grigio Spazzolato Nat. Rett.	102
27PV0R Bianco Sabbbiato Nat. Rett.	102
27PV9R Nero Bruciato Nat. Rett.	102

20x180 - 7^{7/8} x 70^{7/8}"

28PV1R Rovere Puro Nat. Rett.	102
28PV3R Quercia Recuperata Nat. Rett.	102
28PV8R Grigio Spazzolato Nat. Rett.	102
28PV0R Bianco Sabbbiato Nat. Rett.	102
28PV9R Nero Bruciato Nat. Rett.	102

30x120 - 11^{13/16} x 47^{1/4}"

55PV1R Rovere Puro Nat. Rett.	89
55PV3R Quercia Recuperata Nat. Rett.	89
55PV8R Grigio Spazzolato Nat. Rett.	89
55PV0R Bianco Sabbbiato Nat. Rett.	89
55PV9R Nero Bruciato Nat. Rett.	89

20x120 - 7^{7/8} x 47^{1/4}"

54PV1R Rovere Puro Nat. Rett.	89
54PV3R Quercia Recuperata Nat. Rett.	89
54PV8R Grigio Spazzolato Nat. Rett.	89
54PV0R Bianco Sabbbiato Nat. Rett.	89
54PV9R Nero Bruciato Nat. Rett.	89

AntiSlip

54PV1RZ Rovere Puro R11 Nat. Rett.	89
54PV3RZ Quercia Recuperata R11 Nat. Rett.	89
54PV8RZ Grigio Spazzolato R11 Nat. Rett.	89
54PV0RZ Bianco Sabbbiato R11 Nat. Rett.	89
54PV9RZ Nero Bruciato R11 Nat. Rett.	89

40x120 - 15^{3/4} x 47^{1/4}"

20MM

X41PV3R Quercia Recuperata Nat. Rett.	116
X41PV8R Grigio Spazzolato Nat. Rett.	116
X41PV9R Nero Bruciato Nat. Rett.	116

Si consiglia la posa con fuga 2 mm.
Laying with a 2 mm-joint is recommended.
Pose recommandée avec joints de 2 mm.
Es wird eine Fugenbreite von 2 mm empfohlen.
Se recomienda la colocación con juntas de 2 mm. -
Рекомендуется укладка с швом 2 мм.

DECORI DECORS / DECORS / DEKORE / DECORADOS / ДЕКОРЫ

CHEVRON 9,2x54,2 - 3⁵/₈"x21⁵/₁₆"

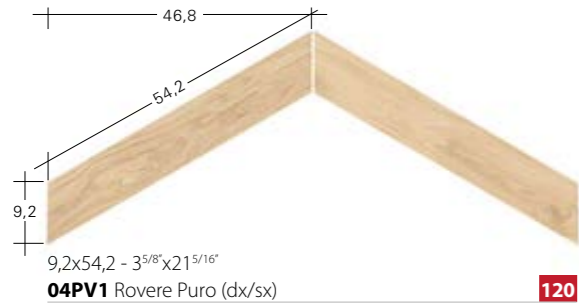

9,2x54,2 - 3⁵/₈"x21⁵/₁₆"
04PV1 Rovere Puro (dx/sx) **120**



9,2x54,2 - 3⁵/₈"x21⁵/₁₆"
04PV3 Quercia Recuperata (dx/sx) **120**



9,2x54,2 - 3⁵/₈"x21⁵/₁₆"
04PV8 Grigio Spazzolato (dx/sx) **120**



9,2x54,2 - 3⁵/₈"x21⁵/₁₆"
04PV0 Bianco Sabbiato (dx/sx) **120**



9,2x54,2 - 3⁵/₈"x21⁵/₁₆"
04PV9 Nero Bruciato (dx/sx) **120**

CHEVRON MONO* 29,4x34 - 11⁹/₁₆"x13³/₈"

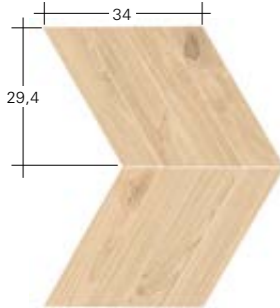

29,4x34 - 11⁹/₁₆"x13³/₈"
H30PV1 (dx/sx)
Rovere Puro **139**



29,4x34 - 11⁹/₁₆"x13³/₈"
H30PV3 (dx/sx)
Quercia Recuperata **139**



29,4x34 - 11⁹/₁₆"x13³/₈"
H30PV8 (dx/sx)
Grigio Spazzolato **139**



29,4x34 - 11⁹/₁₆"x13³/₈"
H30PV0 (dx/sx)
Bianco Sabbiato **139**



29,4x34 - 11⁹/₁₆"x13³/₈"
H30PV9 (dx/sx)
Nero Bruciato **139**

CHEVRON MULTI* 29,4x34 - 11⁹/₁₆"x13³/₈"

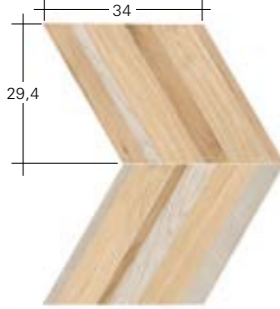

29,4x34 - 11⁹/₁₆"x13³/₈"
H30PV13 (dx/sx)
Rovere / Quercia / Bianco **141**



29,4x34 - 11⁹/₁₆"x13³/₈"
H30PV89 (dx/sx)
Grigio / Bianco / Nero **141**

* Su rete in fibra
On fibre mesh backing
Sur filet en fibre de verre
Auf Glasfasernetz
Sobre malla de fibra
На волоконной сетке



H30PV13 - Chevron Multi Rovere/Quercia/Bianco - 29,4x34 - 11⁹/₁₆"x13³/₈"
28PV1R - Rovere Puro Nat. Rett. - 20x180 - 7⁷/₈"x70⁷/₈"
27PV1R - Rovere Puro Nat. Rett. - 26,5x180 - 7⁷/₁₆"x70⁷/₈"

SESTINO* 30x30 - 11¹³/₁₆"x11¹³/₁₆"

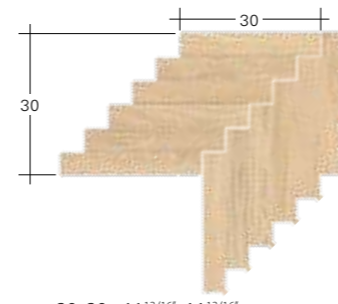

30x30 - 11¹³/₁₆"x11¹³/₁₆"
M30PV1 (dx/sx)
Rovere Puro **133**



30x30 - 11¹³/₁₆"x11¹³/₁₆"
M30PV3 (dx/sx)
Quercia Recuperata **133**



30x30 - 11¹³/₁₆"x11¹³/₁₆"
M30PV8 (dx/sx)
Grigio Spazzolato **133**



30x30 - 11¹³/₁₆"x11¹³/₁₆"
M30PV0 (dx/sx)
Bianco Sabbiato **133**



30x30 - 11¹³/₁₆"x11¹³/₁₆"
M30PV9 (dx/sx)
Nero Bruciato **133**



DECORI DECORS / DECORS / DEKORE / DECORADOS / ДЕКОРЫ

WOODCUT 20x120 - 7⁷/₈"x47¹/₄"



20x120 - 7⁷/₈"x47¹/₄"
54PV1RB Rovere Puro Nat. Rett.

91



20x120 - 7⁷/₈"x47¹/₄"
54PV3RB Quercia Recuperata Nat. Rett.

91



20x120 - 7⁷/₈"x47¹/₄"
54PV8RB Grigio Spazzolato Nat. Rett.

91



20x120 - 7⁷/₈"x47¹/₄"
54PV0RB Bianco Sabbiato Nat. Rett.

91



20x120 - 7⁷/₈"x47¹/₄"
54PV9RB Nero Bruciato Nat. Rett.

91

GRAVEN 20x120 - 7⁷/₈"x47¹/₄"



20x120 - 7⁷/₈"x47¹/₄"
54PV1RC Rovere Puro Nat. Rett.

91



20x120 - 7⁷/₈"x47¹/₄"
54PV3RC Quercia Recuperata Nat. Rett.

91



20x120 - 7⁷/₈"x47¹/₄"
54PV8RC Grigio Spazzolato Nat. Rett.

91

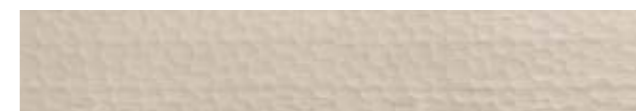

20x120 - 7⁷/₈"x47¹/₄"
54PV0RC Bianco Sabbiato Nat. Rett.

91



20x120 - 7⁷/₈"x47¹/₄"
54PV9RC Nero Bruciato Nat. Rett.

91

TURTLE* 29,8x31,6 - 11³/₄"x12⁷/₁₆"



29,8x31,6 - 11³/₄"x12⁷/₁₆"
R30PV1
 Rovere Puro

152



29,8x31,6 - 11³/₄"x12⁷/₁₆"
R30PV3
 Quercia Recuperata

152



29,8x31,6 - 11³/₄"x12⁷/₁₆"
R30PV8
 Grigio Spazzolato

152



29,8x31,6 - 11³/₄"x12⁷/₁₆"
R30PV0
 Bianco Sabbiato

152



29,8x31,6 - 11³/₄"x12⁷/₁₆"
R30PV9
 Nero Bruciato

152

* Su rete in fibra - On fibre mesh backing
 Sur filet en fibre de verre - Auf Glasfasernetz - Sobre malla de fibra - На волоконной сетке

PROPOSTE DI POSA

INSTALLATIONS SUGGESTIONS / CROQUIS DE POSE / VERLEGUNGSVORSCHLÄGE /
SUGERENCIAS DE COMPOSICION / СХЕМЫ УКЛАДКИ

CHEVRON MONO/MULTI 29,4x34 - 11⁹/₁₆"x13³/₈"



1



2



3



4



SESTINO 30x30 - 11¹³/₁₆"x11¹³/₁₆"



5



6



PEZZI SPECIALI

TRIMS / PIECES SPECIALES / FORMTEILE
PIEZAS ESPECIALES / СПЕЦИАЛЬНЫЕ ИЗДЕЛИЯ



BATTISCOPA - SKIRTING
4,6x120 - 1^{13/16}x47^{1/4}"
B4PV1R Rovere Puro Nat. Rett.
B4PV3R Quercia Recuperata Nat. Rett.
B4PV8R Grigio Spazzolato Nat. Rett.
B4PV0R Bianco Sabbiato Nat. Rett.
B4PV9R Nero Bruciato Nat. Rett.
Pcs. Box. 6 - Ml. x Box 7,20 **32**

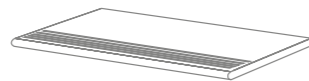

GRADINO - STAIR TREAD
33x120 - 12^{15/16}x47^{1/4}"
74PV1R Rovere Puro Nat. Rett.
74PV3R Quercia Recuperata Nat. Rett.
74PV8R Grigio Spazzolato Nat. Rett.
74PV0R Bianco Sabbiato Nat. Rett.
74PV9R Nero Bruciato Nat. Rett.
Pcs. Box. 2 - Ml. x Box 2,40 **120**



GRADONE - STEP
33x120x3,2x3,2 - 12^{15/16}x47^{1/4}x1^{1/4}x1^{1/4}"
CRPV1R Rovere Puro Nat. Rett.
CRPV3R Quercia Recuperata Nat. Rett.
CRPV8R Grigio Spazzolato Nat. Rett.
CRPV0R Bianco Sabbiato Nat. Rett.
CRPV9R Nero Bruciato Nat. Rett.
Pcs. Box. 2 - Ml. x Box 2,40 **138**



ANGOLARE DX / SX - CORNER TILE DX / SX
33x120x3,2x3,2 - 12^{15/16}x47^{1/4}x1^{1/4}x1^{1/4}"
ACPV1RD / ACPV1RS Rovere Puro Nat. Rett.
ACPV3RD / ACPV3RS Quercia Recuperata Nat. Rett.
ACPV8RD / ACPV8RS Grigio Spazzolato Nat. Rett.
ACPV0RD / ACPV0RS Bianco Sabbiato Nat. Rett.
ACPV9RD / ACPV9RS Nero Bruciato Nat. Rett.
Pcs. Box. 1 - Ml. x Box 1,20 **145**

20MM PEZZI SPECIALI

TRIMS / PIECES SPECIALES / FORMTEILE
PIEZAS ESPECIALES / СПЕЦИАЛЬНЫЕ ИЗДЕЛИЯ



GRADONE - STEP
33x120x5 - 12^{15/16}x47^{1/4}x1^{15/16}"
2GPV3R Quercia Recuperata Nat. Rett.
2GPV8R Grigio Spazzolato Nat. Rett.
2GPV9R Nero Bruciato Nat. Rett.
Pcs. Box. 1 - Ml. x Box 1,20 **138**



ANGOLARE DX / SX - CORNER TILE DX / SX
33x120x5 - 12^{15/16}x47^{1/4}x1^{15/16}"
2GPV3RD / 2GPV3RS Quercia Recuperata Nat. Rett.
2GPV8RD / 2GPV8RS Grigio Spazzolato Nat. Rett.
2GPV9RD / 2GPV9RS Nero Bruciato Nat. Rett.
Pcs. Box. 1 - Ml. x Box 1,20 **145**

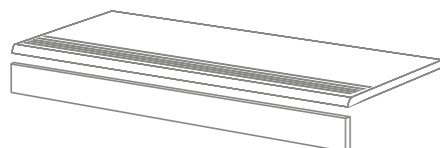

GRADINO - STAIR TREAD
33x120 - 12^{15/16}x47^{1/4}"
4GPV3R Quercia Recuperata Nat. Rett.
4GPV8R Grigio Spazzolato Nat. Rett.
4GPV9R Nero Bruciato Nat. Rett.
Pcs. Box. 1 - Ml. x Box 1,20 **135**

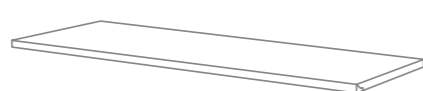

TERMINALE - ENDINGPIECE
33x120x2,5 - 12^{15/16}x47^{1/4}x1^{15/16}"
3GPV3R Quercia Recuperata Nat. Rett.
3GPV8R Grigio Spazzolato Nat. Rett.
3GPV9R Nero Bruciato Nat. Rett.
Pcs. Box. 1 - Ml. x Box 1,20 **138**

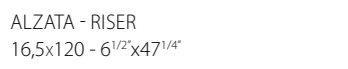

ALZATA - RISER
16,5x120 - 6^{1/2}x47^{1/4}"
2TPV3R Quercia Recuperata Nat. Rett.
2TPV8R Grigio Spazzolato Nat. Rett.
2TPV9R Nero Bruciato Nat. Rett.
Pcs. Box. 1 - Ml. x Box 1,20 **54**



ANGOLO TERMINALE DX / SX - ENDINGPIECE CORNER DX / SX
33x120x2,5 - 12^{15/16}x47^{1/4}x1^{15/16}"
3GPV3RD / 3GPV3RS Quercia Recuperata Nat. Rett.
3GPV8RD / 3GPV8RS Grigio Spazzolato Nat. Rett.
3GPV9RD / 3GPV9RS Nero Bruciato Nat. Rett.
Pcs. Box. 1 - Ml. x Box 1,20 **145**

PROVOAK

Dry - Pressed Ceramic Tiles ISO 13006 Annex G - UNI EN 14411 Annex G - Bla GL



CARATTERISTICHE TECNICHE		NORMA	VALORI		
Technical Features - Caracteristiques Techniques - Technische Eigenschaften Technische Eigenschaften - Caracteristicas Tecnicas - Технические Характеристики		Standard - Norme Norm - Norma - Norma	Value - Valeur Vorgabe - Valor - Средние		
	PLANARITÀ Flatness - Planéité - Ebenflächigkeit - Planaridad - Плоскостность	UNI EN ISO 10545/2	± 0,26% / ± 1,5mm		
		ASTM C485 WARPAGE	-		
		CALIBRATED ± 0,75% (MAX ± 0,09 IN)	-		
	ASSORBIMENTO D'ACQUA (VALORE MEDIO IN %) Water absorption (Average value expressed in %) - Absorption d'eau (Valeur moyenne en %) Wasseraufnahme (Durchschnittswert in %) - Absorción de agua (Valor medio en %) Поглощение воды	UNI EN ISO 10545/3 ≤ 0,5 %	CONFORME		
		ASTM C373	COMPLIANT		
	RESISTENZA ALLA FLESSIONE Modulus of rupture - Resistance à la flexion - Biegefestigkeit Resistencia a la flexion - Прочность на изгиб	UNI EN ISO 10545/4	20MM		
			≥ 50 N/mm ²	≥ 50 N/mm ²	
	FORZA DI ROTTURA Breaking strength - Résistance à la rupture - Bruchlast Resistencia a la rotura - Разрывное усилие	UNI EN ISO 10545/4	≥ 2000 N		
			ASTM C648	700 LBS	
	RESISTENZA AL GELO Frost resistance - Résistance au gel - Frostbeständigkeit - Resistencia a las heladas - Морозостойкость	UNI EN ISO 10545/12 ASTM C1026	CONFORME		
			UNAFFECTED		
	RESISTENZA CHIMICA AD ALTE E BASSE CONCENTRAZIONI DI ACIDI E BASI Chemical resistance to high and low acid and basic concentrations Résistance chimique aux hautes et basses concentrations d'acides et de bases Chemikalienfestigkeit bei hohen und niedrigen Konzentrationen von Säuren und Basen Resistencia química con concentraciones altas y bajas de ácidos y bases Химическая стойкость к высоким и низким концентрациям кислот и щелочей	UNI EN ISO 10545/13 ASTM C-650	GA - GLA - GHA		
			UNAFFECTED		
	RESISTENZA ALLE MACCHIE Stain resistance - Résistance aux taches - Fleckenbeständigkeit Resistencia a las manchas - Стойкость к образованию пятен	UNI EN ISO 10545/14 CTI 81-7D	5		
			NO EVIDENT VARIATION		
	COEFFICIENTE DI ATTRITO Slip resistance - Coefficient de glissement - Rutschfestigkeit Barfußbereich Coeficiente de atrito medio - Коэффициент трения	DIN 51130 DIN 51097 ANSI A 137.1 - 2012 DCOF (SECTION 9.6) B.C.R.A.	NATURALE		
			R10	R11	R11
			B (A+B)	C (A+B+C)	B (A+B)
			WET ≥ 0,42	WET ≥ 0,42	WET ≥ 0,42
			≥ 0,40	≥ 0,40	≥ 0,40

Per maggiori chiarimenti sui dati tecnici e sulla garanzia consultare il catalogo generale in vigore. - For further information on technical specifications, please consult our up-dated general catalogue. - Pour toutes informations supplémentaires sur les données techniques et sur les garanties, veuillez consulter le catalogue général en vigueur. - Für weitere Informationen über technische Daten und Garantie beziehen sie sich bitte auf den aktuellen Gesamtkatalog. - Para posteriores informaciones sobre los datos técnicos y la garantía, vease el catalogo general en vigor. - Более подробную информацию о технических данных и гарантии смотрите в действующем сводном катал.



Articolo Item Reference Artikel Artículo Артикула	Formato (cm) Size (cm) Format (cm) Format (cm) Formato (cm) Формат (cm)	Spessore (mm) Thickness (mm) Epaisseur (mm) Stärke (mm) Espesor (mm) Толщина (mm)	Pz. x Mq. Pieces x Sqm Pcs / M ² Stk. x Qm Pzs x Mc. Шт. x Кв.М.	Pz. x Scat. Pieces x Box Pcs / Bte Stk. x Krt. Pzs x Caja Шт. x Кор.	Mq. x Scat. Sqm x Box M ² / Bte Qm x Krt. Mc. x Caja Кв.М. x Кор.	Peso x Scat. (Kg) Weight x Box (Kg) Poids / Bte (Kg) Gewicht x Krt. (Kg) Peso x Caja (Kg) Вес x Кор. (Kg)	Scat. x Pal. Boxes x Pal. Bte / Pal. Krt. x Pal. Cajas x Pal. Кор. x Подд.	Mq. x Pal. Sqm x Pal. M ² / Pal. Qm x Pal. Mc. x Pal. Кв.М x Подд.	Peso x Pal. (Kg) Weight x Pal. (Kg) Poids / Pal. (Kg) Gewicht x Pal. (Kg) Peso x Pal. (Kg) Вес x Подд. (Kg)
27PV_R	26,5x180	10	2,10	3	1,431	31,68	36	51,52	1140
28PV_R	20x180	10	2,78	4	1,440	31,68	40	57,60	1267
55PV_R	30x120	10	2,78	4	1,440	34,40	36	51,84	1238,4
54PV_R/RZ	20x120	10	4,17	4	0,960	23,50	40	38,40	940
X41PV_R	40x120	20	2,08	1	0,480	22,50	48	23,04	1080
54PV_RB/RC	20x120	10	4,17	4	0,960	23,50	40	38,40	940
04PV_	9,2x54,2	10	20,05	12	0,600	15,00	60	36,00	900
H30PV_	29,4x34	10	10,00	6	0,600	13,50	40	24,00	540
R30PV_	29,8x31,6	10	10,62	5	0,470	12,00	-	-	-
M30PV_	30x30	10	11,11	6	0,540	13,00	-	-	-



PROVENZA



L'essence du chêne rouvre et les veinures compactes du chêne donnent vie à une collection qui surprend par son naturel, son charme et son hétérogénéité. Ce sont justement les différents usinages auxquels est soumis le chêne rouvre qui inspirent le style de Provoak dont la remarquable polyvalence en fait un choix capable de satisfaire tous les goûts, des plus traditionnels aux plus tendance, pour des espaces sur mesure.

Design de la collection

Rovere Puro
Une essence noble et sélectionnée avec des veinures aux lignes ininterrompues, élégantes et harmonieuses, pour un produit rassurant, à l'esprit sobre et minimaliste.

Quercia recuperata
Le choix de vieilles planches naturelles de chêne donne aux intérieurs le charme du temps qui passe et aux surfaces un cachet inestimable.

Grigio spazzolato
Le brossage donne à la surface un toucher doux et soyeux exprimé dans les tons du gris à travers lequel sont rehaussées les veines naturelles du chêne rouvre.

Bianco sabbiato
Le sablage blanchit le bois en mettant en valeur ses veines et en sublimant la tridimensionnalité des surfaces. Un usinage idéal pour créer de splendides espaces contemporains.

Nero bruciato
L'effet de brûlage obtenu par le feu, donne une tonalité foncée particulière qui valorise l'élégance des surfaces en dotant les intérieurs d'une grande élégance.

La finition du décor Graven
reproduit la technique du ciselage. Les traces de ce travail artisanal deviennent des éléments de décoration diversifiés qui rehaussent la tridimensionnalité du produit. Disponible dans toutes les couleurs de la collection Provoak.

Le décor Woodcut affiche une série de découpes qui donnent l'impression d'être faites par scie circulaire. Les signes en surface, de profondeur et longueur différentes, apportent tridimensionnalité au produit qui devient une décoration parfaite pour des murs de classe. Disponible dans toutes les couleurs de la collection Provoak.

20MM

Provoak 20mm offre la possibilité de réaliser des espaces extérieurs d'une grande valeur esthétique, sans toutefois renoncer aux prestations techniques. Les caractéristiques spécifiques de Provoak 20mm permettent d'intégrer parfaitement le matériau à l'environnement ambiant, offrant la possibilité de créer simplement et efficacement des parcours faciles à nettoyer. L'épaisseur de Provoak 20mm garantit une résistance élevée aux charges et aux sollicitations, la rendant idéale pour l'intérieur et l'extérieur des espaces publics. Provoak 20mm est facile à poser sur l'herbe, le sable et le gravier. Une fois collé sur chape, le produit permet de réaliser des sols carrossables pour des espaces industriels et commerciaux. Idéal pour rampes d'accès et garages. Provoak 20mm est idéale pour la création de planchers surélevés.

Die Essenz der Traubeneiche und die eichentypische kompakte Maserung verleihen dieser Kollektion Vielfalt und eine natürliche, faszinierende Ausstrahlung. Die unterschiedlichen Verarbeitungsmöglichkeiten, die sich bei der Traubeneiche bieten, haben den Stil von Provoak maßgeblich beeinflusst. Dank ihrer ausgeprägten Vielseitigkeit entspricht die Kollektion verschiedensten Vorlieben von klassisch bis trendbewusst – für die Gestaltung perfekter Räume nach Maß.

Design der Kollektion

Rovere Puro
Ein nobles Wesen und eine Maserung, die sich durch ununterbrochene, elegante und harmonische Linien auszeichnet – ein stilischeres Produkt für Puristen und Minimalisten.

Quercia recuperata
Die Auswahl natürlicher Dielen aus wiedergewonnener Eiche verleiht dem Raum den faszinierenden Effekt des Laufs der Zeit und den Oberflächen eine buchstäblich erhabene Persönlichkeit.

Grigio spazzolato
Die Oberfläche in unterschiedlichen Grautönen wird durch den Prozess des Anbürstens seidenweich und lässt die natürliche Maserung der Traubeneiche hervortreten.

Bianco sabbiato
Das Verfahren der Sandstrahlung bleicht das Holz aus, lässt die Maserung in den Vordergrund treten und betont die Dreidimensionalität der Oberflächen. Die ideale Wahl für ein ebenso edles wie zeitgenössisches Ambiente.

Nero bruciato
Der über offener Flamme entstehende Brandeffekt verleiht dem Holz eine besondere dunkle Farbe, welche die Eleganz der Oberflächen hervorhebt und ein erlesenes Ambiente perfekt in Szene setzt.

Das Dekor Graven besticht mit einer ausdrucksstarken Oberfläche, die von der Ziselieretechnik inspiriert ist. Die bei dieser handwerklichen Verarbeitung entstehenden Muster bringen die plastische Optik des Produkts zur Geltung. In allen Farben der Kollektion Provoak erhältlich.

Das Dekor Woodcut weist etliche Einschnitte auf, die an Bearbeitungen mit der Kreissäge erinnern. Die Einschnitte von unterschiedlicher Tiefe und Länge verleihen dem Produkt eine eindrucksvolle Tiefenoptik, die sich perfekt für stilvolle Wandverkleidungen eignet. In allen Farben der Kollektion Provoak erhältlich.

20MM

Provoak 20mm bietet eine wertige Optik und ausgezeichnete Leistungsmerkmale und ist die ideale Lösung für die Gestaltung von Außenbereichen. Die spezifischen Eigenschaften von Provoak 20mm gestatten eine perfekte Einbindung des Materials in den räumlichen Kontext und die einfache Gestaltung von Geh- und Fahrwegen im Außenbereich. Die hohe Fliesenstärke von Provoak 20mm gewährleistet eine ausgezeichnete Robustheit. Damit erweist sich die Kollektion als ideal für öffentliche Innen- und Außenbereiche. Provoak 20mm lässt sich problemlos auf Gras, Sand und Kies verlegen. Für befahrbare Bodenbeläge empfiehlt sich die Verbundverlegung auf Estrich. Ideal für Zufahrten und Garagen. Provoak 20mm ist die perfekte Lösung für Doppelböden.

La esencia del roble y las vetas compactas de la encina dan vida a una colección que sorprende por su naturalidad, encanto y variedad. Son precisamente las distintas elaboraciones del roble las que inspiran el estilo de Provoak, cuya marcada versatilidad la convierte en una opción ideal para satisfacer varios tipos de gusto — desde el de inspiración más clásica hasta el más orientado a las últimas tendencias — y para construir perfectos espacios a medida.

Diseño de la colección

Rovere Puro
Esencia noble y selecta con vetas de líneas sin interrupciones, elegantes y armoniosas, que configuran un producto acogedor, de gusto neto y minimal.

Quercia recuperata
La selección de tablas de encina naturales recicladas confiere a los espacios el encanto del paso del tiempo y a las superficies una recia personalidad.

Grigio spazzolato
La elaboración mediante cepillado da suavidad y sedosidad a la superficie en los distintos tonos del gris, poniendo de relieve las vetas naturales del roble.

Bianco sabbiato
La elaboración del arenado blanquea la madera resaltando las vetas y remarcando el carácter tridimensional de las superficies. Perfecta para crear espléndidos espacios contemporáneos.

Nero bruciato
El efecto chamuscado que se consigue gracias a las llamas del fuego, genera un tono oscuro especial que da realce a la elegancia de las superficies confiriendo una gran distinción a los ámbitos.

Graven propone una superficie decorativa que reproduce la técnica del cincelado. Las huellas de esta elaboración artesanal se convierten en elementos decorativos diversos que remarcen el carácter tridimensional del producto. Se halla disponible en todos los colores de la colección Provoak.

Woodcut presenta en la superficie una serie de incisiones que se inspiran en la elaboración mediante sierra circular. Las huellas de la superficie presentan profundidades y longitudes distintas y le confieren tridimensionalidad al producto, convirtiéndolo en el elemento decorativo ideal para embellecer con estilo las paredes. Se halla disponible en todos los colores de la colección Provoak.

20MM

Provoak 20mm ofrece la posibilidad de revestir espacios exteriores de modo estéticamente muy agradable sin por ello tener que renunciar a unas magníficas prestaciones técnicas. Las características específicas de Provoak 20mm permiten integrar perfectamente el material en el entorno, brindando la posibilidad de crear de manera sencilla y eficaz caminos y carriles al aire libre. El elevado grosor de Provoak 20mm garantiza una considerable resistencia, hecho por el que este tipo de material resulta de lo más idóneo para ámbitos públicos, tanto interiores como exteriores. Provoak 20mm se puede colocar fácilmente sobre superficies tan diversas como la hierba, la arena y la grava. Colocado con cola sobre la capa de relleno, permite realizar pavimentaciones transitables industriales y comerciales. Ideal para rampas de acceso y garajes. Provoak 20mm es un material de lo más idóneo para la creación.

Древесина и плотный рисунок дуба вдыхают жизнь в такую коллекцию, которая поражает натуральностью, очарованием и разнообразием. Вдохновением для стиля Provoak послужили именно разнообразные обработки дуба, универсальность которого превращает его в идеальный выбор для удовлетворения различных вкусовых предпочтений, от классического до современного, и для реализации великолепных интерьеров на заказ.

Дизайн коллекции

Rovere Puro
Отобранная и ценная порода дерева, линии рисунка которого непрерывные, элегантные и гармоничные, благодаря чему этот материал внушает доверие и обладает чистым и минималистским вкусом.

Quercia recuperata
Подборка досок из натурального повторно использованного дуба наделяет интерьеры очарованием течения времени, а поверхности - выраженным характером.

Grigio spazzolato
Щеточная обработка делает поверхность мягкой и шелковистой в разнообразных тонах серого, подчеркивая естественный рисунок дуба.

Bianco sabbiato
Пескоструйная обработка отбеливает дерево, подчеркивая рисунок и выделяя объемность поверхности. Отлично подходит для создания великолепных современных интерьеров.

Nero bruciato
Обожженный эффект получается пламенем, которое придает особенный темный цвет, подчеркивающий элегантность поверхности, и наделяющий ею интерьеры.

Graven предлагает декоративную поверхность, которая воспроизводит резьбу по дереву. Отличительные черты этой ремесленной обработки превращаются в разнообразные элементы декора, подчеркивающие объемность изделия. Имеется во всех цветах коллекции Provoak.

Woodcut представляет на поверхности мотив, воспроизводящий обработку циркулярной пилой. Следы на поверхности имеют разную глубину и длину и придают изделию объемность, превращая его в великолепный элемент для стильного оформления стен. Имеется во всех цветах коллекции Provoak.

20MM

С помощью представленной в коллекции Provoak 20mm можно обустроить открытые площадки, придавая им высокую эстетическую ценность и не поступаясь какими-либо техническими характеристиками. Благодаря особым свойствам представленная в коллекции Provoak 20mm гармонирует с окружающей средой. С ее помощью можно легко проложить надежные дорожки и переходы вне помещений. Представленная в коллекции Provoak 20mm отличается высокой прочностью, а потому идеально подходит для обустройства помещений общественных зданий и прилегающих территорий. Представленная в коллекции Provoak 20mm легко укладывается на траву, песок и щебень. Укладка на клей поверх стяжки позволяет обустроить территорию для проезда на промышленных и коммерческих предприятиях. Идеально подходит для наклонных въездов и гаражей. Представленная в коллекции Provoak 20mm идеально подходит для монтажа фальшполов.

PROV**OAK**

PROVENZA

Provenza is a brand of Emilceramica S.r.l. a socio unico	Sede Commerciale/Amministrativa
emilgroup.it/provenza emilgroup.it	Via Ghiarola Nuova, 29 - 41042 Fiorano Modenese (Mo) - Italy T +39 0536 835111 - info@emilceramicagroup.it F (Italy) +39 0536 835958 - (Export) +39 0536 835490