

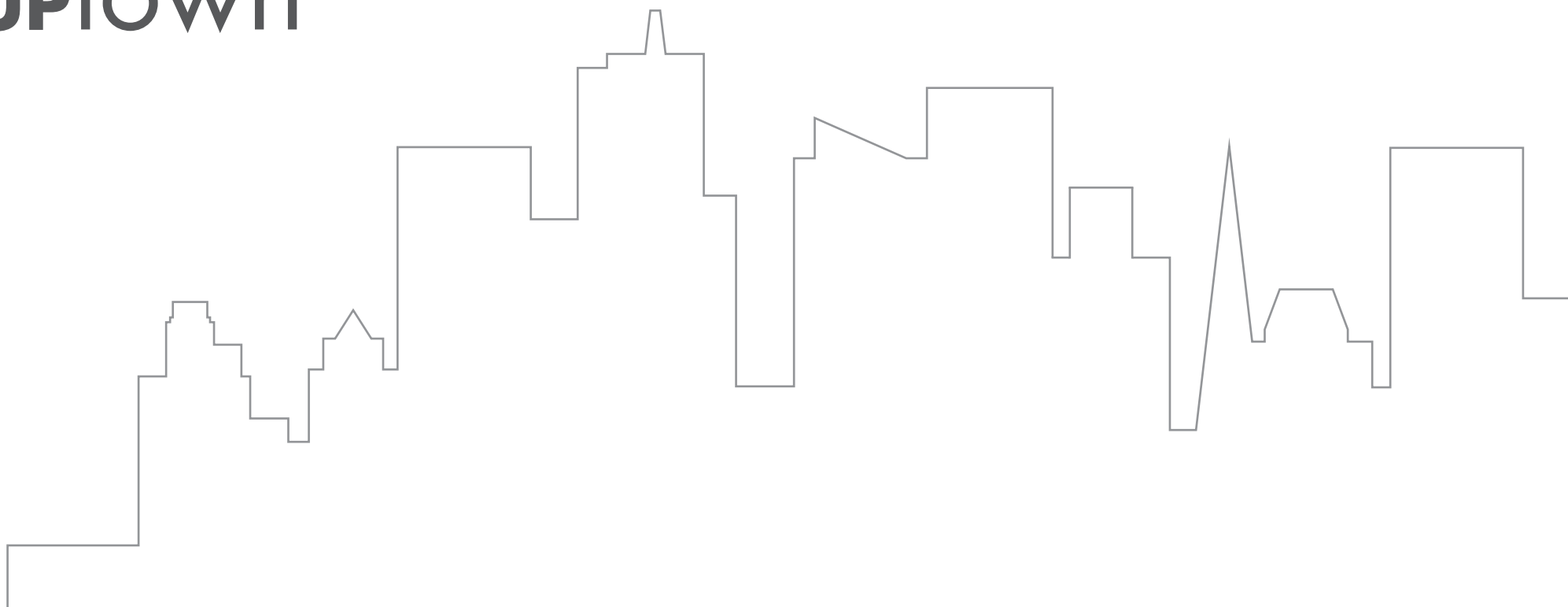

Dom
CERAMICHE

Dom
CERAMICHE

UPTOWN



**la qualità della
ceramica Dom unita
all'essenzialità del cemento**

3 le superfici per valorizzare i tuoi spazi, in 4 tonalità di colore

3 the surface textures to complement your room settings, in 4 shades of color

3 surfaces pour mettre en valeur vos espaces, en 4 nuances de couleur

3 Oberflächen, um Ihre Räume aufzuwerten, in 4 Farbtönen

naturale

rettificato

lappato

White

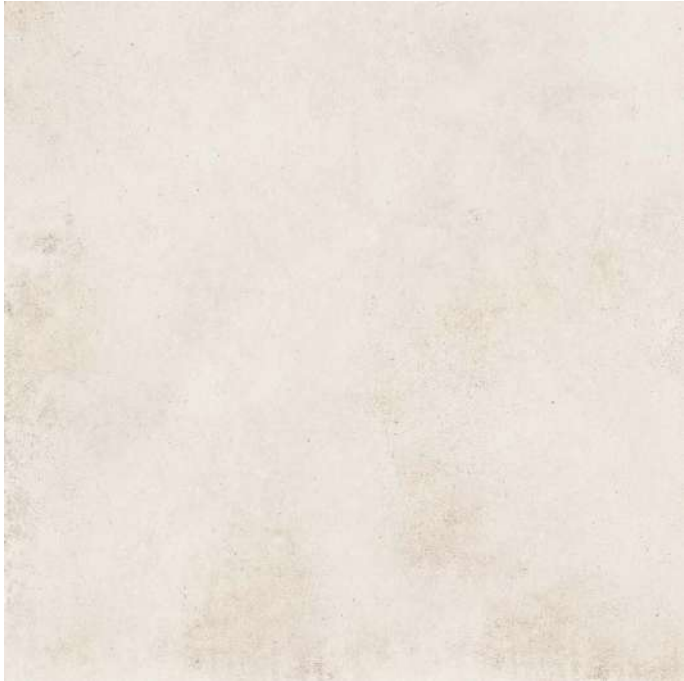

DUT9910R **UPTOWN WHITE** Rett. 90x90 35,4"x35,4"
DUT9910RL **UPTOWN WHITE** Rett./Lapp. 90x90 35,4"x35,4"

626/MQ
648/MQ

Greige



DUT9920R **UPTOWN GREIGE** Rett. 90x90 35,4"x35,4"
DUT9920RL **UPTOWN GREIGE** Rett./Lapp. 90x90 35,4"x35,4"

626/MQ
648/MQ

Lead



DUT9904R **UPTOWN LEAD** Rett. 90x90 35,4"x35,4"
DUT9904RL **UPTOWN LEAD** Rett./Lapp. 90x90 35,4"x35,4"

626/MQ
648/MQ

Silver

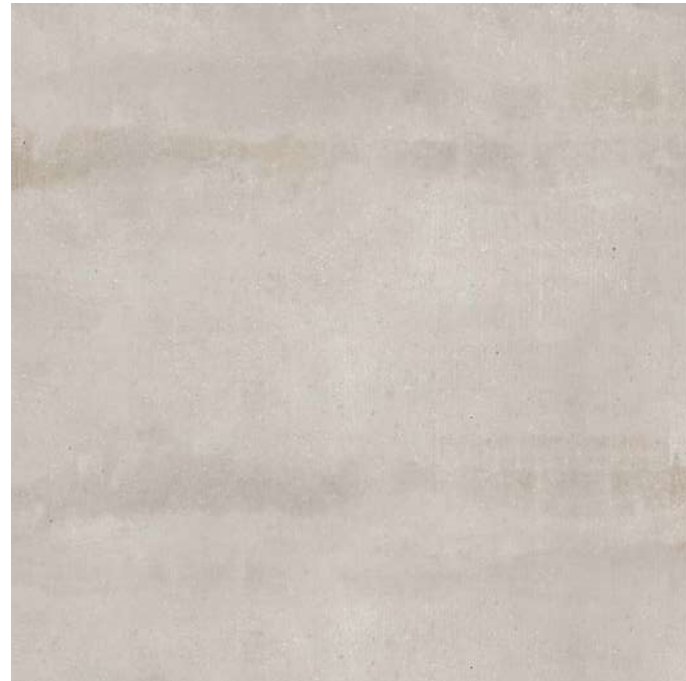

DUT9940R **UPTOWN SILVER** Rett. 90x90 35,4"x35,4"
DUT9940RL **UPTOWN SILVER** Rett./Lapp. 90x90 35,4"x35,4"

626/MQ
648/MQ

UPTOWN

DIGITAL
TECHNOLOGY

PORCELLANATO
IMPASTO COLORATO



pezzi diversi l'uno dall'altro grazie all'uso della tecnologia digitale...

each piece is different from the other thanks to use of digital technology...

éléments différents l'un de l'autre grâce à l'utilisation de la technologie numérique...

ein Teil anders als das andere, dank der Benutzung der digitalen Technologie...

Uptown

DIGITAL
TECHNOLOGY

PORCELLANATO
IMPASTO COLORATO



greige

Greige Rett. Lapp. 59,5x59,5 - 23,4"x23,4"
Greige Out 60x60 - 24"x24"



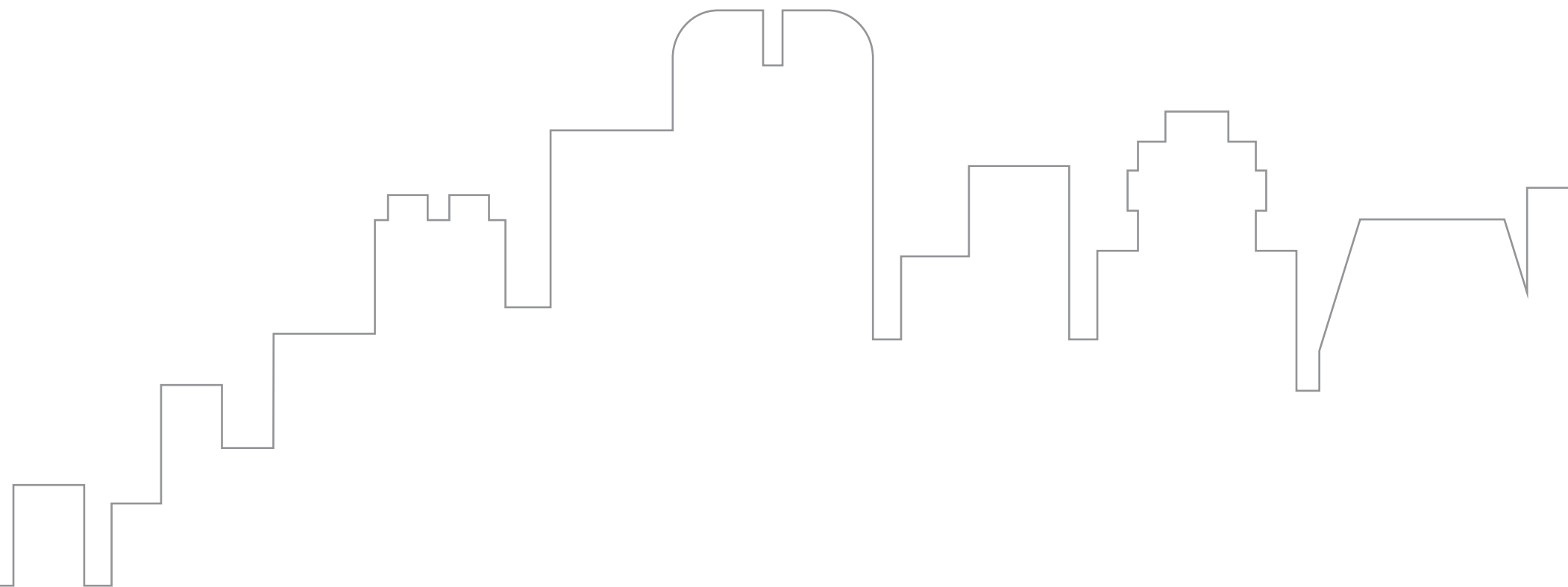

...ogni pezzo è assolutamente unico

...each piece is absolutely unique
...chaque élément est absolument unique
...jedes Teil ist absolut einzigartig







silver

Silver Rett. 44,5x90 - 17,5"x35,4"
Silver Rett. Lapp. 44,5x90 - 17,5"x35,4"
Listello Steel 1,5x90 - 0,6"x35,4"



Uptown

DIGITAL
TECHNOLOGY

PORCELLANATO
IMPASTO COLORATO



Silver Rett. 44,5x90 - 17,5"x35,4"
14 Silver Rett. Lapp. 44,5x90 - 17,5"x35,4" - Listello Steel 1,5x90 - 0,6"x35,4"







Silver 60x60 - 24"x24"
Silver 30x60 - 12"x24"
Multi dekor Silver 30x60 - 12"x24"

UPTOWN



silver

Multi dekor Silver 30x60 - 12"x24"
18 Smooth White 20x60 - 8"x24"



Uptown

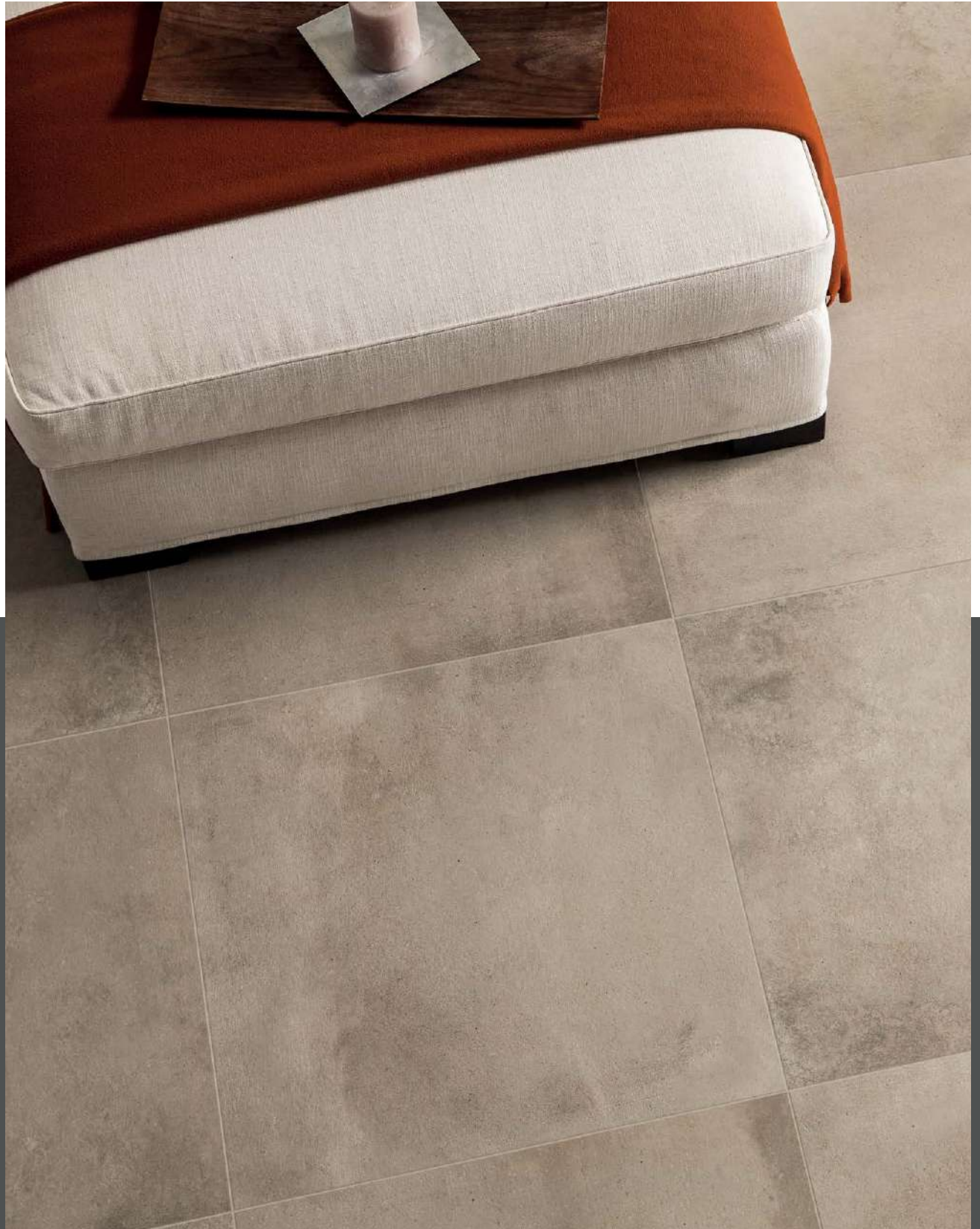

greige



UPTOWN

75x150
30"x60"

White



DUT71510R **UPTOWN WHITE** Rett. 75x150 30"x60"

646/MQ

Greige



DUT71520R **UPTOWN GREIGE** Rett. 75x150 30"x60"

646/MQ

Lead



DUT71504R **UPTOWN LEAD** Rett. 75x150 30"x60"

646/MQ

Silver



DUT71540R **UPTOWN SILVER** Rett. 75x150 30"x60"

646/MQ

UPTOWN

45,5x91 - 44,5x90 - 60x60 - 59,5x59,5 - 30x60 - 29,6x59,5
18,2"x36,4" - 17,5"x35,4" - 24"x24" - 23,4"x23,4" - 12"x24" - 11,8"x23,4"

White



DUT310 **UPTOWN WHITE** 30x60 12"x24" **574/MQ**
DUT310R **UPTOWN WHITE** Rett. 29,6x59,5 11,8"x23,4" **582/MQ**

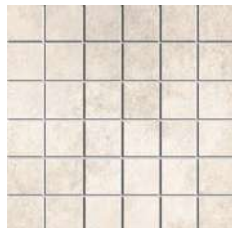

DUTM10 **UPTOWN WHITE MIX** (Tozz. 5x5) **534/PZ**
30x30 12"x12"



DUT310RL **UPTOWN WHITE** Rett./Lapp. **590/MQ**
29,6x59,5 11,8"x23,4"



DUT610 **UPTOWN WHITE** 60x60 24"x24" **583/MQ**
DUT610R **UPTOWN WHITE** Rett. 59,5x59,5 23,4"x23,4" **592/MQ**



DUT610RL **UPTOWN WHITE** Rett./Lapp. **599/MQ**
59,5x59,5 23,4"x23,4"



DUT910 **UPTOWN WHITE** 45,5x91 18,2"x36,8" **587/MQ**
DUT910R **UPTOWN WHITE** Rett. 44,5x90 17,5"x35,4" **596/MQ**



DUT910RL **UPTOWN WHITE** Rett./Lapp. 44,5x90 17,5"x35,4" **604/MQ**

Greige



DUT320 UPTOWN GREIGE 30x60 12"x24" **574/MQ**
DUT320R UPTOWN GREIGE Rett. 29,6x59,5 11,8"x23,4" **582/MQ**



DUTM20 UPTOWN **534/PZ**
GREIGE MIX (Tozz. 5x5)
30x30 12"x12"



DUT320RL UPTOWN GREIGE Rett./Lapp. **590/MQ**
29,6x59,5 11,8"x23,4"



DUT620 UPTOWN GREIGE 60x60 24"x24" **583/MQ**
DUT620R UPTOWN GREIGE Rett. 59,5x59,5 23,4"x23,4" **592/MQ**



DUT620RL UPTOWN GREIGE Rett./Lapp. **599/MQ**
59,5x59,5 23,4"x23,4"



DUT920 UPTOWN GREIGE 45,5x91 18,2"x36,8" **587/MQ**
DUT920R UPTOWN GREIGE Rett. 44,5x90 17,5"x35,4" **596/MQ**



DUT920RL UPTOWN GREIGE Rett./Lapp. 44,5x90 17,5"x35,4" **604/MQ**

UPTOWN

45,5x91 - 44,5x90 - 60x60 - 59,5x59,5 - 30x60 - 29,6x59,5
18,2"x36,4" - 17,5"x35,4" - 24"x24" - 23,4"x23,4" - 12"x24" - 11,8"x23,4"

Lead



DUT304 **UPTOWN LEAD** 30x60 12"x24" **574/MQ**
DUT304R **UPTOWN LEAD** Rett. 29,6x59,5 11,8"x23,4" **582/MQ**



DUTM04 **UPTOWN LEAD MIX** (Tozz. 5x5) **534/PZ**
30x30 12"x12"



DUT304RL **UPTOWN LEAD** Rett./Lapp. **590/MQ**
29,6x59,5 11,8"x23,4"



DUT604 **UPTOWN LEAD** 60x60 24"x24" **583/MQ**
DUT604R **UPTOWN LEAD** Rett. 59,5x59,5 23,4"x23,4" **592/MQ**



DUT604RL **UPTOWN LEAD** Rett./Lapp. **599/MQ**
59,5x59,5 23,4"x23,4"



DUT904 **UPTOWN LEAD** 45,5x91 18,2"x36,8" **587/MQ**
DUT904R **UPTOWN LEAD** Rett. 44,5x90 17,5"x35,4" **596/MQ**



DUT904RL **UPTOWN LEAD** Rett./Lapp. 44,5x90 17,5"x35,4" **604/MQ**

Silver



DUT340 **UPTOWN SILVER** 30x60 12"x24" **574/MQ**
DUT340R **UPTOWN SILVER** Rett. 29,6x59,5 11,8"x23,4" **582/MQ**



DUTM40 **UPTOWN SILVER MIX** (Tozz. 5x5) **534/PZ**
30x30 12"x12"



DUT340RL **UPTOWN SILVER** Rett./Lapp. **590/MQ**
29,6x59,5 11,8"x23,4"



DUT640 **UPTOWN SILVER** 60x60 24"x24" **583/MQ**
DUT640R **UPTOWN SILVER** Rett. 59,5x59,5 23,4"x23,4" **592/MQ**



DUT640RL **UPTOWN SILVER** Rett./Lapp. **599/MQ**
59,5x59,5 23,4"x23,4"



DUT940 **UPTOWN SILVER** 45,5x91 18,2"x36,8" **587/MQ**
DUT940R **UPTOWN SILVER** Rett. 44,5x90 17,5"x35,4" **596/MQ**



DUT940RL **UPTOWN SILVER** Rett./Lapp. 44,5x90 17,5"x35,4" **604/MQ**

UPTOWN

Decori - Decors

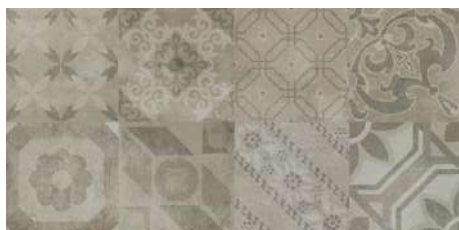

DUT32MD MULTI DEKOR GREIGE
(set 4 pz) 30x60 12"x24"

583/MQ

DUT32MDR MULTI DEKOR GREIGE Rett.
(set 4 pz) 29,6x59,5 11,8"x23,4"

594/MQ

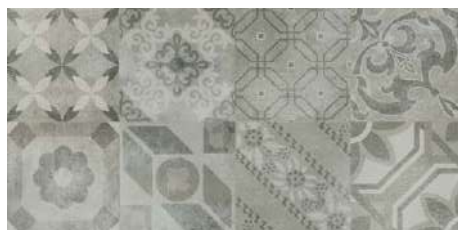

DUT34MD MULTI DEKOR SILVER
(set 4 pz) 30x60 12"x24"

583/MQ

DUT34MDR MULTI DEKOR SILVER Rett.
(set 4 pz) 29,6x59,5 11,8"x23,4"

594/MQ

CONSIGLI PER LA POSA

POSA A CORRERE - La posa a "correre" necessita una maggiore premura nelle fasi di livellaggio e accostamento dei singoli pezzi, per poter attenuare eventuali differenze di planarità. Sebbene inevitabili queste piccole differenze non compromettono un buon risultato finale: dunque è consigliato sfalsare i singoli pezzi di 15-20 cm massimo.
IMPORTANTE - La posa sfalsata al 50% non è consigliata. Trattandosi di materiali ceramici si suggeriscono le seguenti pose:

FIXING ADVICE

PARALLEL FIXING - To minimize differences in the flatness of the tiles, "parallel" fixing requires greater attention when the individual tiles are positioned and levelled. Although these small differences are inevitable, they will not spoil a good final result: the individual tiles should thus be staggered 15-20 cm at most.
IMPORTANT - Please note that fixing in a 50% staggered configuration is not recommended. We suggest the following fixing configurations for these ceramic materials:

CONSEILS DE POSE

POSE A FOND PERDU - La pose à "fond perdu" nécessite une très grande attention dans les phases de nivellement et d'assemblage des différentes pièces, de manière à atténuer les différences éventuelles de planéité. Ces petites différences sont inévitables, mais ne compromettent pas un bon résultat final: il faut donc décaler les différentes pièces de 15-20 cm maximum.
IMPORTANT - A pose décalée à 50% n'est pas recommandée. Pour les matériaux céramiques nous conseillons les poses suivantes:

TIPPS ZUR VERLEGUNG

FORTLAUFENDE VERLEGUNG - Die fortlaufende Verlegung (eine Platte nach der anderen) erfordert mehr Sorgfalt beim Ebenen und Anlegen der einzelnen Teile, um eventuelle Ebenheitsunterschiede zu mindern. Obwohl sie unvermeidlich sind, stellen diese kleinen Unterschiede keine Beeinträchtigung des guten Endergebnisses dar: Es ist deshalb ratsam, die einzelnen Teile um max. 15-20 cm zu versetzen.
WICHTIG! - Die um 50% versetzte Verlegung nicht empfohlen ist. Da es sich um Keramikmaterial handelt, kann man die folgenden Verlegungen empfehlen:

RECOMENDACIONES PARA LA COLOCACIÓN

COLOCACIÓN LONGITUDINAL - La colocación longitudinal necesita un mayor cuidado en las fases de nivelación y colocación de las piezas individuales, para poder atenuar posibles diferencias de planicidad. No obstante son inevitables, estas pequeñas diferencias no impiden la obtención de un buen resultado final: se recomienda escalonar las piezas individuales con un máximo de 15-20 cm.
IMPORTANTE - La colocación escalonada al 50% no se recomienda. Puesto que se trata de materiales cerámicos, se recomiendan las siguientes colocaciones:

КОМПАНИЯ

ПАЛУБНАЯ УКЛАДКА Палубная укладка требует большего внимания на этапе выравнивания и смыкания отдельных единиц, чтобы уменьшить возможные различия плоскости. Несмотря на то, что эти небольшие различия неизбежны, они не влияют на конечный результат: поэтому рекомендуется располагать отдельные единицы зигзагом максимум в 15-20 см.
ВАЖНО: не рекомендована укладка зигзагом в 50%. Так как речь идет о керамических материалах, рекомендуются следующие методы укладки:

SÌ POSA 10%/20%



NO POSA 50%

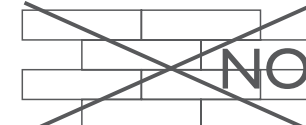

Nelle scatole la disposizione delle piastrelle è casuale ed alcune potrebbero ripetersi: si consiglia quindi di miscelare i pezzi prima delle pose.

In the boxes, the sequence of the various faces is random and some could be repeated: it is therefore recommended to mix tiles, from different boxes and different from each other, before starting the laying.

La composition des boîtes est faite avec des pièces différentes prises au hasard, encore que certains d'entre eux pourraient se répéter dans la même boîte: pour cela on conseille d'ouvrir plusieurs boîtes au même temps et de mélanger les pièces avant la pose.

Boxen in der Anordnung der Fliesen ist zufällig und einige vielleicht wiederholt werden: Es wird vorgeschlagen, um die Stücke platziert, bevor mischen.

En las cajas la disposición de las baldosas es casual y algunas podrían estar repetidas: se recomienda por tanto mezclar las piezas antes de la colocación.

В коробках расположение плитки случайно, некоторые могут повторяться, поэтому рекомендуется смешать единицы материала перед укладкой.

Pezzi speciali - Special Pieces



DUTB10	UPTOWN WHITE BATTISCOPA	9x60 3,5"x24"	513/PZ
DUTB20	UPTOWN GREIGE BATTISCOPA	9x60 3,5"x24"	
DUTB40	UPTOWN SILVER BATTISCOPA	9x60 3,5"x24"	
DUTB04	UPTOWN LEAD BATTISCOPA	9x60 3,5"x24"	



DUTBR10	UPTOWN WHITE BATTISCOPA Rett.	9x59,5 3,5"x23,4"	514/PZ
DUTBR20	UPTOWN GREIGE BATTISCOPA Rett.	9x59,5 3,5"x23,4"	
DUTBR40	UPTOWN SILVER BATTISCOPA Rett.	9x59,5 3,5"x23,4"	
DUTBR04	UPTOWN LEAD BATTISCOPA Rett.	9x59,5 3,5"x23,4"	



DUTBRL10	UPTOWN WHITE BATTISCOPA Rett. Lapp.	9x59,5 3,5"x23,4"	514/PZ
DUTBRL20	UPTOWN GREIGE BATTISCOPA Rett. Lapp.	9x59,5 3,5"x23,4"	
DUTBRL40	UPTOWN SILVER BATTISCOPA Rett. Lapp.	9x59,5 3,5"x23,4"	
DUTBRL04	UPTOWN LEAD BATTISCOPA Rett. Lapp.	9x59,5 3,5"x23,4"	

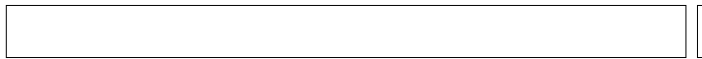

DUTBR910	UPTOWN WHITE BATTISCOPA Rett.	7x90 2,8"x35,4"	524/PZ
DUTBR920	UPTOWN GREIGE BATTISCOPA Rett.	7x90 2,8"x35,4"	
DUTBR940	UPTOWN SILVER BATTISCOPA Rett.	7x90 2,8"x35,4"	
DUTBR904	UPTOWN LEAD BATTISCOPA Rett.	7x90 2,8"x35,4"	

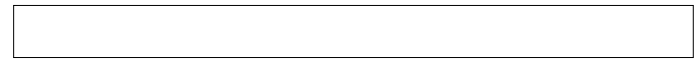

DUTBRL910	UPTOWN WHITE BATTISCOPA Rett. Lapp.	7x90 2,8"x35,4"	524/PZ
DUTBRL920	UPTOWN GREIGE BATTISCOPA Rett. Lapp.	7x90 2,8"x35,4"	
DUTBRL940	UPTOWN SILVER BATTISCOPA Rett. Lapp.	7x90 2,8"x35,4"	
DUTBRL904	UPTOWN LEAD BATTISCOPA Rett. Lapp.	7x90 2,8"x35,4"	

SCALINO COSTA RETTA

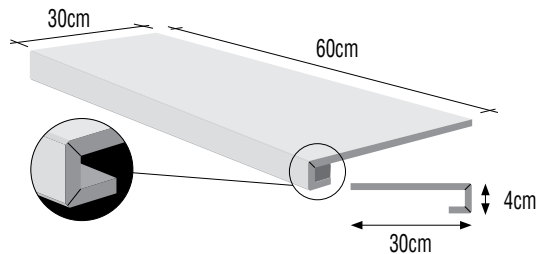

DUTS310	UPTOWN WHITE SCALINO C. RETTA	30x60x4	12"x24"x1,6"	679/PZ
DUTS320	UPTOWN GREIGE SCALINO C. RETTA	30x60x4	12"x24"x1,6"	
DUTS340	UPTOWN SILVER SCALINO C. RETTA	30x60x4	12"x24"x1,6"	
DUTS304	UPTOWN LEAD SCALINO C. RETTA	30x60x4	12"x24"x1,6"	

SCALINO COSTA RETTA

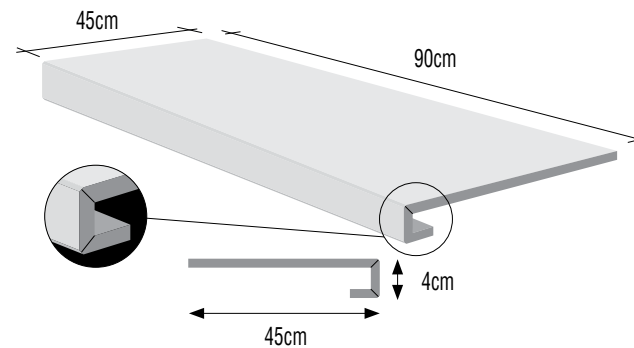

* DUTS910	UPTOWN WHITE SCALINO C. RETTA Rett.	45x90x4	17,7"x35,4"x1,6"	765/PZ
DUTS920	UPTOWN GREIGE SCALINO C. RETTA Rett.	45x90x4	17,7"x35,4"x1,6"	
DUTS940	UPTOWN SILVER SCALINO C. RETTA Rett.	45x90x4	17,7"x35,4"x1,6"	
DUTS904	UPTOWN LEAD SCALINO C. RETTA Rett.	45x90x4	17,7"x35,4"x1,6"	

* Pezzo speciale venduto al pezzo con consegna di 30 giorni lavorativi
 Special item sold by the piece with consignment after 30 work days
 Pièce spéciale vendue à la pièce, livraison en 30 jours ouvrables
 Stückweise verkaufte Formstück mit Lieferzeit von 30 Werktagen
 Piezas especiales vendidas por pieza con entrega en 30 días laborables
 Специальная единица, проданная поштучно, доставка в течение 30 рабочих дней



superfici per esterni che coniugano design e modernità alle prestazioni antiscivolo R11 antislip A+B+C

surface textures for outdoors that combine design and contemporaneity
with R11 antislip A+B+C performance

surfaces pour extérieur qui allient design et modernité aux performances
antidérapantes R11 "antislip" A+B+C

Oberflächen für den Außenbereich, die Design und Modernität mit
trittfesten Eigenschaften R11 antislip A+B+C vereinen

UPTOWN OUT

90x90 - 60x60
35,4"x35,4" - 24"x24"

White

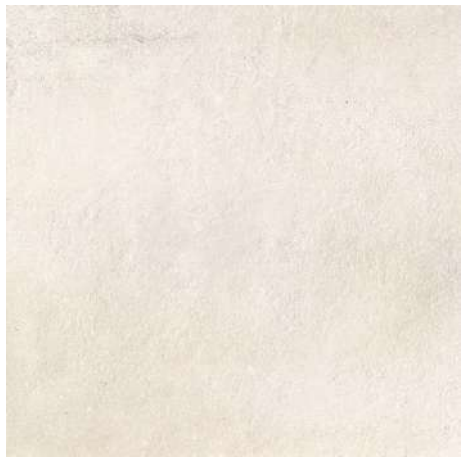

DUT6100 UPTOWN WHITE Out
60x60 24"x24"

587/MQ

Greige



DUT6200 UPTOWN GREIGE Out
60x60 24"x24"

587/MQ

Lead



DUT6040 UPTOWN LEAD Out
60x60 24"x24"

587/MQ

Silver

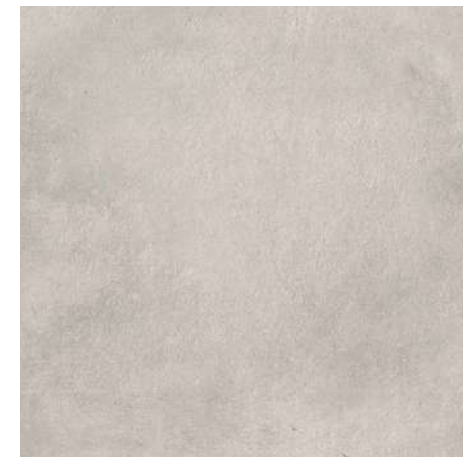

DUT6400 UPTOWN SILVER Out
60x60 24"x24"

587/MQ

Silver



630/MQ

Lead



630/MQ

Pezzi speciali
Special Pieces

SCALINO COSTA RETTA

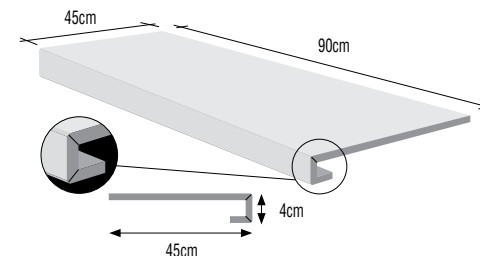

Misure e prezzi a richiesta.
Sizes and prices on request.
Dimensions et prix sur demande.
Formate und Preise auf Anfrage.
Medidas y precios bajo petición.
Размеры и цены по запросу













Pezzo speciale venduto al pezzo con consegna di 30 giorni lavorativi
Special item sold by the piece with consignment after 30 work days
Pièce spéciale vendue à la pièce, livraison en 30 jours ouvrables
Stückweise verkaufte Formstück mit Lieferzeit von 30 Werktagen
Piezas especiales vendidas por pieza con entrega en 30 días laborables
Специальная единица, проданная поштучно, доставка в течение 30 рабочих дней



lead

Lead Out 60x60 - 24"x24"
Lead Rett. 59,5x59,5 - 23,4"x23,4" 33

FORMATO size format format	Pz./SCATOLA pieces/box pieces/boîte stück/karton	Mq./SCATOLA sqm/box m²/boîte qm/karton	Kg./SCATOLA Kg/box Kg/boîte Kg/karton	Sc./PALLET boxes/pallet boîtes/palette kartons/palette	Mq./PALLET sqm/pallet m²/palette qm/palette	Kg./PALLET Kg/pallet Kg/palette Kg/palette	SPESSORE Thickness Epaisseurs Stärke
75x150 / 30"x60" rett.	1	1,125	27,70	24	27,00	685	10,5mm
90x90 / 35,4"x35,4" rett.	2	1,620	36,00	20	32,40	735	10mm
90x90 / 35,4"x35,4" rett./lapp.	2	1,620	36,00	20	32,40	735	10mm
45,5x91 / 18,2"x36,8"	3	1,242	28,70	32	39,74	933	10mm
44,5x90 / 17,5"x35,4" rett.	3	1,200	28,50	32	38,40	927	10mm
44,5x90 / 17,5"x35,4" rett./lapp.	3	1,200	28,50	32	38,40	927	10mm
60x60 / 24"x24"	4	1,440	32,11	30	43,20	978	10mm
59,5x59,5 / 23,4"x23,4" rett.	4	1,440	32,11	30	43,20	978	10mm
59,5x59,5 / 23,4"x23,4" rett./lapp.	4	1,440	32,11	30	43,20	978	10mm
30x60 / 12"x24"	6	1,080	23,40	40	43,20	951	10mm
29,6x59,5 / 11,8"x23,4" rett.	5	0,900	21,70	40	36,00	883	10mm
29,6x59,5 / 11,8"x23,4" rett./lapp.	5	0,900	21,70	40	36,00	883	10mm
90x90 / 35,4"x35,4" out	2	1,620	36,00	20	32,40	735	10mm
60x60 / 24"x24" out	4	1,440	32,11	30	43,20	978	10mm
60x60 / 24"x24" out 20MM	2	0,720	45,14	32	23,04	1.459	20mm
30x60 / 12"x24" multi dekor	6	1,080	23,40	40	43,20	951	10mm
29,6x29,6 / 11,8"x11,8" multi dekor rett.	5	0,900	21,70	40	36,00	883	10mm
30x30 / 12"x12" mix	4	-	-	-	-	-	-
9x60 / 3 ^{3/5} "x24" battiscopa	12	-	-	-	-	-	-
9x59,5 / 3 ^{3/5} "x23,4" battiscopa rett.	12	-	-	-	-	-	-
9x59,5 / 3 ^{3/5} "x23,4" battiscopa rett./lapp.	12	-	-	-	-	-	-
7x90 / 3,5"x35,4" battiscopa rett.	6	-	-	-	-	-	-
7x90 / 3,5"x35,4" battiscopa rett./lapp.	6	-	-	-	-	-	-
30x60x4 / 12"x24"x1,6" scalino c. retta	2	-	-	-	-	-	-
45x90x4 / 17,7"x35,4"x1,6" scalino c. retta rett.	2	-	-	-	-	-	-

Dati tecnici secondo norme: Technical data conform to: Caractéristiques techniques d'après normes: Technische Daten nach den Normen: EN 14411 B1, GL			UPTOWN nat.	UPTOWN out	UPTOWN lapp.		UPTOWN nat.	UPTOWN out	UPTOWN lapp.		
	Caratteristiche tecniche Technical data Caractéristiques techniques Technische Daten	Norme Normes Normes Norm	Valori Value Valeur Wert	Valori Value Valeur Wert	Valori Value Valeur Wert		Valori Value Valeur Wert	Valori Value Valeur Wert	Valori Value Valeur Wert		
	Resistenza all'abrasione Abrasion resistance Résistance à l'abrasion Abrasionswiderständigkeit	ISO 10545-7	PEI V	PEI V	PEI IV		Resistenza alle macchie Stain resistance Résistance aux taches Fleckenfestigkeit	ISO 10545-14	Totale Complete Totale Absolut	Totale Complete Totale Absolut	Totale Complete Totale Absolut
	Assorbimento d'acqua Water absorption Absorption d'eau Wasseraufnahme	ISO 10545-3	≤ 0,1%	≤ 0,1%	≤ 0,1%		Scivolosità Slipperiness Degré de glissement Rutschhemmung	DIN 51130	R10	R11	
	Resistenza alla flessione Breaking modulus Résistance à la flexion Biegefestigkeit	ISO 10545-4	40±55 N/mm2	40±55 N/mm2	40±55 N/mm2		Resistenza allo scivolamento Slip resistance Résistance au glissement Rutschhemmung	DIN 51097	B	C	
	Resistenza al gelo Resistance to frost Résistance au gel Frostbeständigkeit	ISO 10545-12	Non gelive Frost proof Ingélif Frostsicher	Non gelive Frost proof Ingélif Frostsicher	Non gelive Frost proof Ingélif Frostsicher		Scivolamento B.C.R.A. Slipperiness B.C.R.A. Degré de glissement B.C.R.A. Rutschhemmung B.C.R.A.	TORTUS	WET > 0,58 DRY > 0,69	WET > 0,96 DRY > 0,96	
	Resistenza all'attacco acido e basico Glaze resistance to acid and alkaline attack Resistance aux acides et aux bases Säure-und laugenfestigkeit	ISO 10545-13	Resiste Resists Resiste Bestanding	Resiste Resists Resiste Bestanding	Resiste Resists Resiste Bestanding	ASTM	Scivolosità Slipperiness Degré de glissement Rutschhemmung	ASTM C1028	WET > 0,64 DRY > 0,75	WET > 1,00 DRY > 1,16	
	Durezza Mohs Mohs hardness Dureté Mohs Haerte Mohs	EN101	6	6	6		Stonizzazione Shading Denuançage Spielfarbig		V3	V3	V3
	La lista completa e aggiornata dei prodotti certificati è visionabile sul sito www.cstb.fr . Per ulteriori informazioni contattare Ascot o Dom Ceramiche. The complete and updated list of certified products is available on the website www.cstb.fr . For further information contact Ascot or Dom Ceramiche. La liste complète et mise à jour des produits certifiés peut être consulté sur le site www.cstb.fr . Pour plus d'information contacter Ascot ou Dom Ceramiche. Die vollständige und aktualisierte Liste der zertifizierten Produkte kann auf der folgenden Website eingesehen werden: www.cstb.fr . Für weitere Informationen wenden Sie sich an Ascot oder Dom Ceramiche.										

I valori indicati nella tabella si riferiscono alle prove eseguite sul colore WHITE.
The values in the table refer to the tests performed on color WHITE.
Les valeurs indiquées dans le tableau se réfèrent aux essais exécutés sur le couleur WHITE.

Die in der Tabelle angegebenen Werte beziehen sich auf die Tests die auf dem Farbe WHITE ausgeführt wurden.
Los valores indicados en la tabla se refieren a las pruebas realizadas sobre el color WHITE.
Указанные в таблице значения относятся к испытаниям, проведенным на бежевом оттенке WHITE.





SEDE COMMERCIALE
STRADA STATALE 569, N°167/A
ITALY - 41014 SOLIGNANO (MO)
TEL +39 059 75.77.911
FAX +39 059 75.77.966
info@domceramiche.it
www.domceramiche.it

