

MADE IN ITALY. MADE TO EXCEL.

KLIF



 **atlas concorde**

April 2019



STONE LOOK

KLIF

Porcelain and wall tiles

INDEX

Overview



Spaces

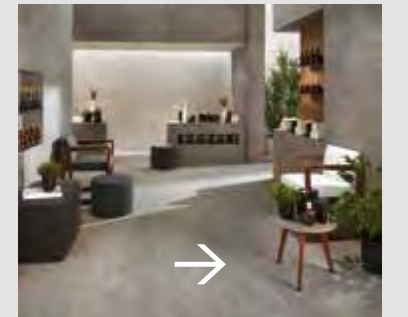
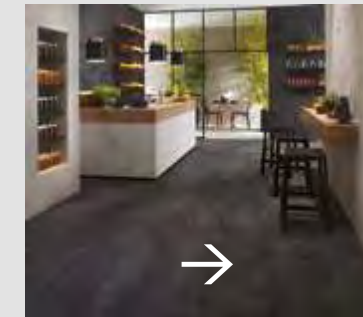
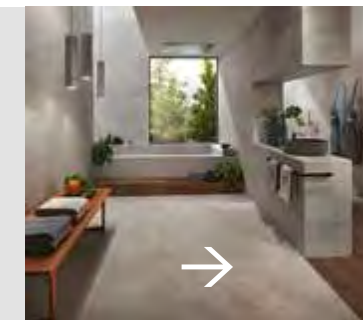

Product Range



Technical Specifications

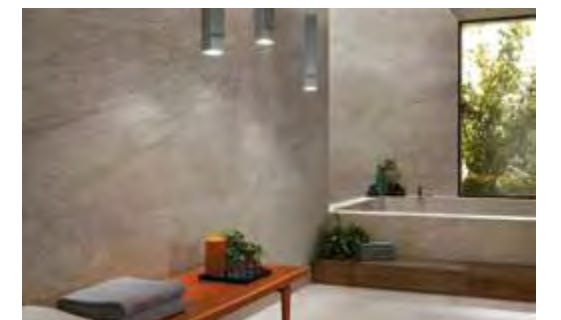

CERAMIC AND PORCELAIN TILES: THE SAFE CHOICE.

● IT DOES NOT BURN
Non brucia

● IT LOVES THE ENVIRONMENT
Ama l'ambiente

● ZERO PVC
Zero PVC

● SAFE
Sicuro

● ZERO VOCS
Zero VOC

● VERSATILE
Versatile

● LONG LASTING
Dura a lungo

● HYGIENIC
Igienico

● RECYCLABLE
Riciclabile

● RESISTANT
Resistente

PURE STRENGTH



FORWARD TO /THE ORIGINS

The decisive elegance of stone comes to life in a collection inspired by beola stone of Val d'Ossola. Placed in the center of the environment, the surfaces become the focus with a great visual power that reflects your tastes.

L'eleganza decisa della pietra rivive in una collezione ispirata alla beola della Val d'Ossola. Messe al centro della scena, le superfici diventano protagoniste di ambienti dalla grande forza visiva, in cui è bello riconoscersi.

La grande élégance de la pierre est revisitée dans une collection qui s'inspire de la beola du Val d'Ossola. Placées au centre de la scène, ces surfaces deviennent les protagonistes d'espaces de grande force visuelle qui mettent chacun à l'aise.

La elegancia refinada de la piedra toma vida en una colección inspirada en la beola de la Val d'Ossola. Las superficies cobran protagonismo en los ambientes cargados de potente fuerza visual, en los que nos reconocemos así mismo.

Die charaktervolle Eleganz des Natursteins lebt in einer Kollektion wieder auf, die den Beola-Stein aus dem Ossolatal nachempfunden hat. Die ganz in den Mittelpunkt des Geschehens gerückten Oberflächen lassen Räume von großer visueller Kraft entstehen, in denen man sich gerne wiedererkennt.

Строгая элегантность камня возрождается в коллекции, вдохновленной гнейсом Беола долины Вал д'Оссола. Выразительная поверхность плит становится эффектной доминантой пространств, отражающих наш характер.

POWERFUL ELEGANCE



Contemporary architecture takes its inspiration from nature and goes further, making it the focal point of the spaces. Klif reinterprets the decisive elegance of stone to give life to spaces of solid expressiveness, where you can feel in harmony with the environment.

L'architettura contemporanea prende ispirazione dalla natura e si spinge oltre, fino a renderla protagonista degli ambienti. Klif reinterpreta l'eleganza decisa della pietra per dare vita a spazi dalla solida espressività, dove sentirsi in armonia con l'ambiente.

L'architecture contemporaine puise son inspiration dans la nature, et va bien au-delà, elle la rend protagoniste de l'espace. Klif réinterprète la grande élégance de la pierre pour donner naissance à des espaces de grande expressivité où se sentir en parfaite harmonie.

La arquitectura contemporánea se inspira en la naturaleza llegando a convertirla en protagonista de los ambientes. Klif reinterpreta la elegancia decidida de la piedra dando vida a espacios de fuerte expresividad, haciéndonos sentir parte del entorno que nos rodea.

Die zeitgenössische Architektur inspiriert sich an der Natur und geht noch weiter: sie rückt sie ganz in den Vordergrund des Raums. Klif ist eine neue Interpretation der charaktervollen Eleganz dieses Natursteins und lässt Räume mit solider Ausdruckskraft entstehen, in denen die Harmonie mit der Umwelt spürbar ist.

Современная архитектура не просто черпает вдохновение в природе, а превращает ее в главный элемент обстановки. Klif по-новому интерпретирует строгую элегантность камня, создавая выразительные, пронизанные гармонией пространства.



DESIGNED BY NATURE

DELICATE STRENGTH



Realism is one of the strong points of the surface, which faithfully reproduces the veins and shading typical of beola stone. Surface roughness and quartz crystals create the same sparkling effects as natural stone.

Il realismo è uno dei punti di forza della superficie, che riproduce fedelmente le venature e le sfumature tipiche della beola. Asperità superficiali e cristalli di quarzo creano gli stessi effetti di riflessione luminosa della pietra naturale.

Le réalisme est un des points forts de cette surface qui reproduit fidèlement les veinures et les tonalités typiques de la beola. Les aspérités superficielles et les cristaux de quartz créent les mêmes reflets lumineux de la pierre naturelle.

Uno de los puntos fuertes de la superficie es el realismo ya que reproduce fielmente las vetas y los matices típicos de la beola. Asperezas superficiales y cristales de cuarzo crean los mismos reflejos de luz de la piedra natural.

Beeindruckender Realismus ist eine der starken Seiten der Oberfläche, die die für den Beola typischen Äderungen und Nuancen getreu wiedergibt. Oberflächige Unebenheiten und Kristallquarze erzeugen die gleichen Lichtreflexe wie der Naturstein.

Реализм – одна из главных характеристик коллекции, которая с точностью воспроизводит прожилки и цветовые оттенки камня Beola. Шероховатость поверхности и кварцевые кристаллы рождают такое же свечение, как на исходном природном камне.





NATURAL FORCE

NATURE **ON** STAGE

INDEX

OVERVIEW

SPACES

RANGE

TECH. SPECS



In the most spectacular spaces of contemporary architecture, the earthy surface of the stone effect creates a background full of atmosphere designed to accommodate your style. Beauty takes center stage.

Negli spazi più scenografici dell'architettura contemporanea, la superficie materica dell'effetto pietra crea uno sfondo carico di atmosfera, disegnato per accogliere il tuo stile. La bellezza diventa la protagonista assoluta.

Dans les espaces les plus scénographiques de l'architecture contemporaine, la surface effet pierre crée une toile de fond remplie d'atmosphère, dessinée à votre image. La beauté devient la protagoniste absolue.

En los espacios más escenográficos de la arquitectura contemporánea, la superficie materica de efecto piedra crea un fondo lleno de atmósfera, diseñado para acoger tu propio estilo. La belleza se convierte en la protagonista absoluta.

In den effektivsten Räumen der zeitgenössischen Architektur bildet die stoffliche Oberfläche der Natursteinoptik eine stimmungsvolle Kulisse für Ihren persönlichen Stil. In dem die Schönheit an erster Stelle steht.

В роскошных декорациях современной архитектуры, фактурная поверхность под камень рождает харизматичную атмосферу, созданную, чтобы отражать стиль хозяев. Красота становится центральным элементом обстановки.

OPEN TO NATURE



NATURE AS ARCHITECTURE

The stone effect expresses the beauty of living in spaces that foster a relationship with the environment, where the dialog between indoors and outdoors is always open.

L'effetto pietra esprime la bellezza di vivere in spazi che privilegiano il rapporto con l'ambiente, in cui il dialogo tra interno ed esterno è sempre aperto.

L'effet pierre exprime la beauté de vivre dans des espaces qui privilégient le rapport avec l'environnement, où le dialogue est toujours ouvert entre l'intérieur et l'extérieur.

El efecto piedra ensalza el encanto de vivir plenamente en espacios que privilegian la relación con el entorno, en los que el diálogo entre interior y exterior está siempre abierto.

Die Natursteinoptik bringt die Schönheit eines Lebens in Räumen zum Ausdruck, die die Beziehung zur Umwelt in den Mittelpunkt stellen. In einem stets offenen Dialog zwischen Innen und Außen.

Рисунок камня рождает натуральную и приятную для проживания обстановку, в которой внутренние и наружные пространства образуют единое гармоничное целое.



A DELICATE FORCE

In contemporary architecture with rigorous style, the play of contrasts between light and dark surfaces defines architectural volumes and the various functional areas, designing the spaces of your everyday life.

In un'architettura contemporanea dallo stile rigoroso, il gioco di contrasti tra le superfici chiare e scure definisce i volumi architettonici e le diverse aree funzionali, disegnando gli spazi della tua quotidianità.

Dans une architecture contemporaine au style rigoureux, le jeu de contrastes entre les surfaces claires et foncées définit les volumes architecturaux et les différentes zones fonctionnelles, en dessinant les espaces du quotidien.

In einer zeitgenössischen Architektur mit klaren Linien definiert ein Spiel mit den Kontrasten zwischen hellen und dunklen Oberflächen architektonische Volumen und unterschiedliche Funktionsbereiche, und gliedert so die Räume des täglichen Lebens.

En una arquitectura contemporánea de estilo riguroso, el juego de contrastes entre las superficies claras y oscuras definen los volúmenes arquitectónicos y las diferentes áreas funcionales, diseñando las áreas de la vida cotidiana.

В строгой современной архитектуре игра контрастов светлых и темных поверхностей делит пространства повседневной жизни на разные функциональные зоны.

PORCELAIN TILES /

KLIF Grey 75x150 cm - 29 1/2" x 59"
KLIF Dark 75x150 cm - 29 1/2" x 59"
KLIF Dark Scalino 75 37,5x75 cm - 14 1/4" x 29 1/2"
KLIF Silver Brick 37,5x75 cm - 14 1/4" x 29 1/2"

OUTDOOR PAVING

KLIF Silver 20mm 45x90 cm - 17 3/4" x 35 3/8"
-
ARBOR Cognac 18,5x150 cm - 7 1/4" x 59"



STRONG AND DELICATE AT THE SAME TIME



GENUINE /IMPRINTING





atlas concorde

KLIF GREY

Klif's microstructure reproduces the look of a split-stone surface with extreme precision.

La microstruttura di Klif permette di riprodurre con precisione estrema la superficie a spacco della pietra di ispirazione.



atlas concorde

TRUE **BEAUTY**

The material reproduces the unique characteristics of beola stone with extreme realism: the banded structure, the surface covered by soft veins and the quartz crystals that illuminate the shades of gray.

Il materiale riproduce con estremo realismo le caratteristiche uniche della beola: la struttura lamellare, la superficie percorsa da venature morbide, i cristalli di quarzo che illuminano i toni del grigio.



MATERIAL ARCHITECTURE



atlas concorde



atlas concorde



atlas concorde

- Durable over time.
Durevole e inalterabile nel tempo.

- **Frost and thermal shock resistant.**
 Ingelivo, resistente ad elevate escursioni termiche.

atlas concorde

REDEFINING THE /STONE EFFECT

The 20 mm outdoor pavers have superior technical properties that make it possible to design coordinated interior and exterior spaces that guarantee visual continuity.

I pavimenti per esterni in 20 mm dalle elevate proprietà tecniche permettono di progettare in modo coordinato spazi interni ed esterni di design, garantendo la continuità visiva.



AUTHENTICALLY /STONE

Thanks to its intensely natural inspiration, the characteristic beauty of beola stone lends itself to wellness and hospitality spaces.

Grazie alla sua ispirazione profondamente naturale, l'estetica fortemente caratterizzata della beola si presta ai luoghi del benessere e dell'ospitalità.

Grâce à son inspiration profondément naturelle, l'esthétisme fortement caractérisé de la beola se prête facilement aux lieux du bien-être et de l'hospitalité.

Dank seines höchst natürlichen, am Beola-Stein inspirierten Aussehens eignet sich das Produkt für Wellness-Bereiche ebenso wie für das Gastgewerbe.

Gracias a la inspiración profundamente natural, la personalidad y fuerza estética que caracteriza la beola, la convierte en la ideal para colocarla en lugares dedicados al bienestar y a la hospitalidad.

Благодаря своей глубокой натуральности, фактура гнейса Beola идеально подходит для велнес-салонов, отелей, кафе.



atlasconcorde

WALL TILES /

KLIF Silver 40x80 cm - 15 1/2"x31 1/2"
KLIF 3D Row Silver 40x80 cm - 15 1/2"x31 1/2"
KLIF 3D Silver Corner 1,4x40 cm - 5 1/2"x15 1/2"
KLIF Silver Corner 1,4x40 cm - 5 1/2"x15 1/2"
KLIF Silver Corner A.E. 1,4x1,4 cm - 5 1/2"x5 1/2"

PORCELAIN TILES /

KLIF Silver 75x150 cm - 29 1/2"x59"
-
ARBOR Tobacco 18,5x150 cm - 7 1/2"x59"

TIMELESS AMBIENCE



atlas concorde

FEELING *GOOD*



atlas concorde

ROUGH / ELEGANCE

The rough elegance of the chiseled texture of 3D Wall Row adds three-dimensionality to the sink area, emphasizing the style of the curtain wall.

La ruvida eleganza della texture a effetto scalpello del 3D Wall Row dona tridimensionalità alla zona lavabo, enfatizzando lo stile della cortina muraria.



● The three-dimensional structure of the surface makes the material realistic and natural.
La struttura tridimensionale della superficie rende il materiale realistico e naturale.



KLIF WALL TILES 3D ROW SILVER

atlas concorde

The rough expressiveness of hand-chiseled stone is brought to life in a contemporary manner in the texture of 3D Row.

La ruvida espressività della pietra scalpellata a mano rivive in chiave contemporanea nel rilievo 3D Row.

INDEX

OVERVIEW

SPACES

RANGE

TECH. SPECS



atlas concorde

- **Water resistance makes it ideal for wet areas in wellness centers and spas.**
La resistenza all'acqua lo rende ideale per le zone umide di centri benessere e SPA.

INSPIRED BY WELLNESS

Klif's earthy porcelain surface is the ideal solution for spa environments: on a conceptual level it recalls the beauty of stone, and from a practical point of view it ensures maximum safety.

La superficie materica in gres porcellanato di Klif è la soluzione ideale per l'ambiente spa: a livello concettuale richiama la bellezza della pietra, dal punto di vista funzionale assicura la massima sicurezza.



atlas concorde



atlas concorde

KLIF SILVER

The beauty of split stone is enhanced by the great reliability of porcelain tiles.

L'estetica della pietra da taglio è valorizzata dalla grande affidabilità del gres porcellanato.

EVERYWHERE / WITH STYLE

The outdoor pavers reflect the unique character and colors of the indoor tiles, creating a visual continuity that provides balance to prestigious architectural solutions.

Le pavimentazioni per esterni ricalcano le peculiarità estetiche e i cromatismi degli interni, creando una continuità visiva che dona equilibrio a soluzioni architettoniche di prestigio.

Les sols d'extérieur reproduisent les particularités esthétiques et les chromatismes des intérieurs, en créant une continuité visuelle qui donne de l'équilibre aux solutions architecturales de prestige.

Die Bodenbeläge für Außenbereiche weisen die gleichen optischen Besonderheiten und Farbeffekte auf wie jene der Innenräume, so dass optische Kontinuität entsteht. Harmonische Lösungen für prestigevolle Bauobjekte.

Los pavimentos para exteriores reflejan las peculiaridades estéticas y los cromatismos de los interiores, creando una continuidad visual que confiere equilibrio a las soluciones arquitectónicas de prestigio.

Уличный керамогранит, перенимая рисунок и цвета у интерьерного, придает всему архитектурному проекту гармоничную цельность и ноту престижа.



BEAUTY AND
PRESTIGE

PORCELAIN TILES /
OUTDOOR PAVING
KLIF Grey 20mm 90x90 cm - 35°/x35°/1°



atlas concorde



atlas concorde



NO LIMITS TO DESIGN

With four shades and seven formats, including the new 90x90 cm with a thickness of 20 mm, the extensive, versatile range offers unlimited design possibilities.

Con quattro tonalità in scala cromatica e sette formati, tra cui il nuovo 90x90 a spessore 20 mm, l'ampia e versatile gamma permette possibilità progettuali senza limiti.

DESIGNED FOR OUTDOOR

The 20 mm thick formats and the anti-slip Grip finish make it possible to design environments with total visual continuity between the inside and outside, for a final effect with great impact.

I formati a spessore 20 mm e la finitura antiscivolo Grip permettono di concepire ambienti in totale continuità visiva tra interno ed esterno, per un effetto finale di grande impatto.

- Slip-resistant even when water is present on the surface.
Resistente allo scivolamento anche in presenza di acqua.

PORCELAIN TILES /
KLIF Grey Grip 37,5x75 cm - 14 7/8"x29 1/2"
OUTDOOR PAVING
KLIF Grey 20mm 45x90 cm - 17 3/4"x35 3/8"
KLIF Grey 20mm Round 45x90 cm - 17 3/4"x35 3/8"
KLIF Grey 20mm Round Ang.Sx 45x90 cm - 17 3/4"x35 3/8"
KLIF Grey 20mm Round Ang.Dx 45x90 cm - 17 3/4"x35 3/8"
KLIF Grey 20mm Elemento L Angolare 33x33 cm - 13"x13"
KLIF Grey 20mm Alzata 20x90 cm - 7 7/8"x35 3/8"





atlas concorde



atlas concorde

SPECIAL SOLUTIONS FOR DREAMY SPACES

The range includes an array of special pieces for the pool, intended for exclusive architectural projects with a strong visual impact.

La gamma comprende una serie di pezzi speciali per il bordo piscina, destinati a progetti architettonici esclusivi e dal forte impatto scenografico.



FREEDOM / TO CHOOSE



PORCELAIN TILES /
KLIF Grey 75x150 cm - 29 1/2" x 59"
OUTDOOR PAVING
KLIF Grey ± 20mm 45x90 cm - 17 1/4" x 35 3/8"

● Resistant to scratching and wear.
Resistente al graffio e all'usura.



atlasconcorde

Combining beauty, practicality, and extreme versatility, the stone-inspired collection opens up new perspectives of design.

Coniugando bellezza, funzionalità ed estrema versatilità della gamma, la collezione ispirata alla pietra apre nuove prospettive alla progettazione.

A PRESTIGIOUS CHOICE



atlasconcorde

FEELING / BALANCED

The white-body wall tiles reveal the deep inspiration of natural stone without sacrificing the properties of ceramics, thus guaranteeing easy cleaning and removal of stains.

Il rivestimento in pasta bianca rivela la profonda ispirazione alla pietra naturale senza rinunciare alle proprietà della ceramica, che garantisce semplicità di pulizia e di rimozione delle macchie.

Le revêtement mural en pâte blanche s'inspire de la pierre naturelle sans renoncer aux propriétés de la céramique qui garantissent la simplicité de nettoyage et d'élimination des taches.

Der weißscherbige Wandbelag besticht mit seiner überaus getreuen Natursteinoptik, die er mit den Vorzügen der Keramik vereint: Reinigung und Fleckenentfernung sind ein Kinderspiel.

El revestimiento de pasta blanca interpreta fielmente la piedra natural fuente de inspiración, conservando las propiedades de la cerámica y garantiza simplicidad de limpieza y facilidad para eliminar las manchas.

Настенная плитка из белой глины воссоздает фактуру камня без отказа от таких преимуществ керамики, как простота ухода и удаления пятен.

ATLAS CONCORDE — Klif



WALL TILES /

KLIF White 40x80 cm - 15 7/8" x 31 1/2"
KLIF 3D Row White 40x80 cm - 15 7/8" x 31 1/2"
KLIF White Corner 1,4x40 - 7/8" x 15 7/8"
KLIF 3D White Corner 1,4x40 - 7/8" x 15 7/8"

PORCELAIN TILES /

KLIF White 37,5x75 cm - 14 7/8" x 29 1/2"
KLIF Silver Triangles 28,5x33 cm - 11 1/4" x 13"
KLIF Silver Brick 37,5x75 cm - 14 7/8" x 29 1/2"

OUTDOOR PAVING

KLIF Silver 20mm 45x90 cm - 17 3/4" x 35 3/8"
-
ARBOR Natural 18,5x90 cm - 7 1/4" x 35 3/8"

atlas concorde

PRISTINE ELEGANCE

INDEX

OVERVIEW

SPACES

RANGE

TECH. SPECS



atlas concorde

THE ENERGY OF NATURE

Le revêtement mural en pâte blanche s'inspire de la pierre naturelle sans renoncer aux propriétés de la céramique qui garantissent la simplicité de nettoyage et d'élimination des taches.

El revestimiento de pasta blanca interpreta fielmente la piedra natural fuente de inspiración, conservando las propiedades de la cerámica y garantiza simplicidad de limpieza y facilidad para eliminar las manchas.

Der weißscherbige Wandbelag besticht mit seiner überaus getreuen Natursteinoptik, die er mit den Vorzügen der Keramik vereint: Reinigung und Fleckenentfernung sind ein Kinderspiel.

Настенная плитка из белой глины воссоздает фактуру камня без отказа от таких преимуществ керамики, как простота ухода и удаления пятен.



atlas concorde



atlas concorde



KLIF
WALL TILES
3D ROW
WHITE

atlas concorde

The sculptural three-dimensional ceramic wall reflects the beautiful look of the chiseled texture.

La scultorea parete ceramica tridimensionale riflette l'estetica eccelsa della texture a effetto scalpello.

INDEX

OVERVIEW

SPACES

RANGE

TECH. SPECS

PURE / WHITE



● Easy to clean
micro-textured surface.
Superficie micro-strutturata
semplice da pulire.



KLIF WALL TILES WHITE

atlas concorde

The white-body wall tiles perfectly combine the functionality of ceramics with the original beauty of the stone effect.

Il rivestimento in pasta bianca coniuga alla perfezione la funzionalità della ceramica con la bellezza originaria dell'effetto pietra.



atlas concorde

- **A high resistance to water and humidity makes porcelain tiles inert to the action of mold and fungi.**
L'alta resistenza all'acqua e all'umidità rende il gres porcellanato inerte all'azione di muffe e funghi.

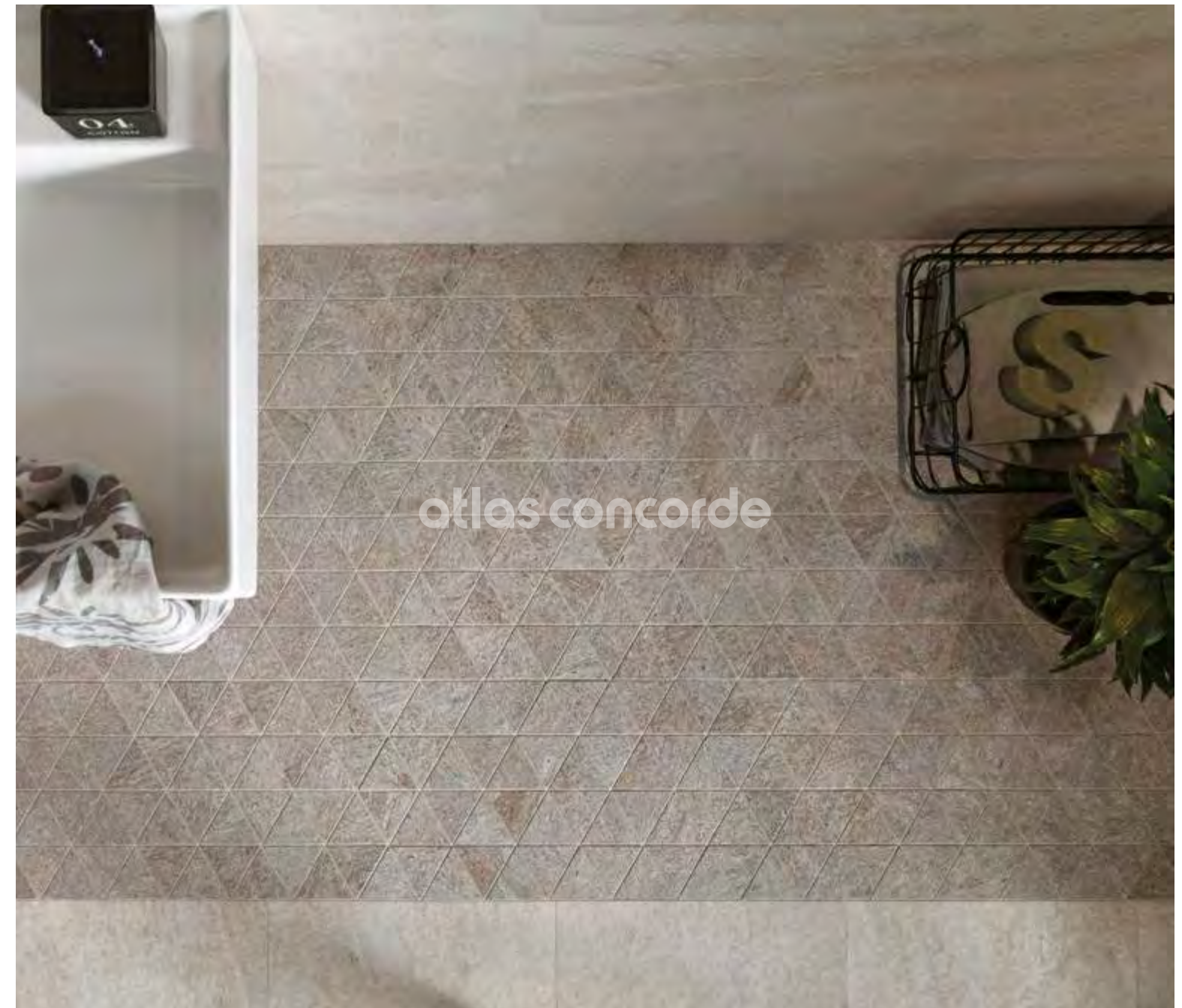

atlas concorde

FREEDOM *of* EXPRESSION

A modern interpretation of cut decorations, the Triangles mosaic underscores the appeal of stone with its refined and balanced geometry.

Moderna interpretazione dei decori da taglio, il mosaico Triangles enfatizza il fascino della pietra con la sua geometria ricercata ed equilibrata.

FEELING / BALANCED

The innate elegance of beola stone allows the design of environments characterized by pure and essential beauty, an expression of a strong and rigorous personality.

L'eleganza innata della beola permette di concepire ambienti caratterizzati da un'estetica pura ed essenziale, espressione di una personalità decisa e rigorosa.

L'élégance innée de la beola permet de concevoir des espaces caractérisés par un esthétisme pur et minimaliste, une expression de grand caractère.

Die dem Beola-Stein eigene Eleganz lässt Räume mit reiner und schlichter Ästhetik entstehen, als Ausdruck einer entschlossenen und konsequenten Persönlichkeit.

Por la elegancia innata de la beola es posible crear ambientes caracterizados por una estética pura y esencial, expresión de una personalidad precisa y rigurosa.

Врожденная элегантность гнейса Beola дает возможность создавать лаконичные, строгие и в то же время яркие по характеру интерьеры.

PORCELAIN TILES /
KLIF Dark 75x150 cm - 29 1/2"x59"
KLIF Silver 75x150 cm - 29 1/2"x59"
KLIF Dark Brick 3D 28x55 cm - 11"x21 1/4"
KLIF Silver Brick 3D 28x55 cm - 11"x21 1/4"
-
ARBOR Cognac 18,5x150 cm - 7 1/4"x59"

atlas concorde

**SURROUNDED
BY NATURE**



● The surface guarantees high resistance to stains. La superficie garantisce un'elevata resistenza alle macchie.



INFINITE / BEAUTY

The beauty of stone from Val d'Ossola returns to life in an extremely reliable and durable material that guarantees maximum resistance to stains and wear.

L'estetica della pietra della Val d'Ossola rivive in un materiale estremamente affidabile e duraturo, che garantisce la massima resistenza alle macchie e all'usura.



- **Hygienic: does not absorb dirt and is easy to clean.**
Igienico: non assorbe sporco ed è facile da pulire.



atlas concorde

KLIF DARK

The earthy vigor of the surface is softened by the delicate movement of the veins within.

La forza materica della superficie è ammorbidita dal movimento delicato delle venature che la disegnano.



● **Impact and wear resistant: suitable for commercial venues.**
Resistente agli urti e all'usura: è ideale in contesti commerciali.

atlas concorde

A PERFECT / SYNTHESIS

Combining the decisive appeal of stone with the characteristic reliability of porcelain tiles, Klif is the perfect synthesis of beauty and practicality.

Coniugando il fascino deciso della pietra con l'affidabilità caratteristica del gres porcellanato, Klif si rivela la perfetta sintesi tra estetica e funzionalità.



atlas concorde



atlas concorde

TIMELESS / ELEGANCE

Elegant stone-effect porcelain tile surfaces meet spectacular three-dimensional ceramic walls, whose refined sculptural impact is rich in light and shadows.

Eleganti superfici in gres porcellanato effetto pietra incontrano scenografiche pareti ceramiche tridimensionali, il cui raffinato impatto scultoreo è ricco di luci e ombre.



INDEX

OVERVIEW

SPACES

RANGE

TECH. SPECS

CONTEMPORARY / STONE

The beauty of stone is rendered contemporary to become a refined floor and wall covering, capable of creating spaces that are both rigorous and enveloping.

L'estetica della pietra entra nella contemporaneità per diventare un rivestimento ricercato, capace di spazi rigorosi e al contempo avvolgenti.

L'esthétisme de la pierre entre dans la contemporanéité pour devenir un revêtement raffiné, capable de créer des espaces à la fois rigoureux et enveloppants.

Die Steinoptik hält Einzug in das moderne Innendesign und wird zum ausgesuchten Wandbelag, der Strenge und Behaglichkeit zugleich vermittelt.

La estética de la piedra natural entra en la época contemporánea para llegar a ser un revestimiento decorativo, creando espacios rigurosos y al mismo tiempo acogedores.

Рисунок камня приобретает современное звучание, и превращается в изысканный декор строгих и, в то же время, пленительных интерьеров.

WALL TILES /
KLIF 3D Row White 40x80 cm - 15³/₄"x31¹/₂"

PORCELAIN TILES /
KLIF Grey 75x150 cm - 29¹/₂"x59"
KLIF Grey 37,5x75 cm - 14¹/₂"x29¹/₂"
KLIF White Brick 3D 28x55 cm - 11"x21⁵/₈"

-
ARBOR Cognac 18,5x150 cm - 7¹/₄"x59"

atlas concorde

NATURAL
WELCOME



atlas concorde

EXTREME / VERSATILITY



atlas concorde



atlas concorde



THE DIMENSION **OF** LIGHT

With its linear cut and the expressiveness of the chiseled texture, 3D Row gives the walls a contemporary look.

Con il suo andamento lineare e l'espressività della texture scalpellata, il rilievo 3D Row dona alle pareti un look contemporaneo.





atlasconcorde

WELCOME TO / THE ELEGANCE

The earthy aspect of stone creates an evocative environment in contemporary spaces, proving to be an appropriate choice even for reception areas.

L'aspetto materico della pietra arricchisce di suggestioni uno spazio dalle linee contemporanee, rivelandosi una scelta appropriata anche per gli ambienti destinati all'accoglienza.



atlasconcorde

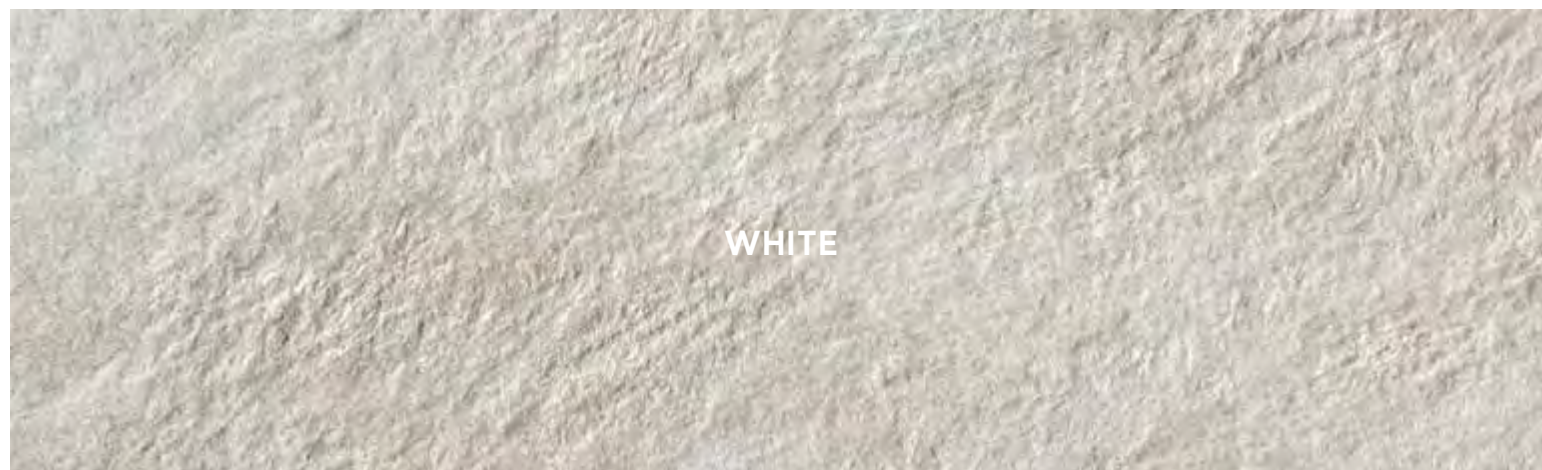

WHITE



SILVER

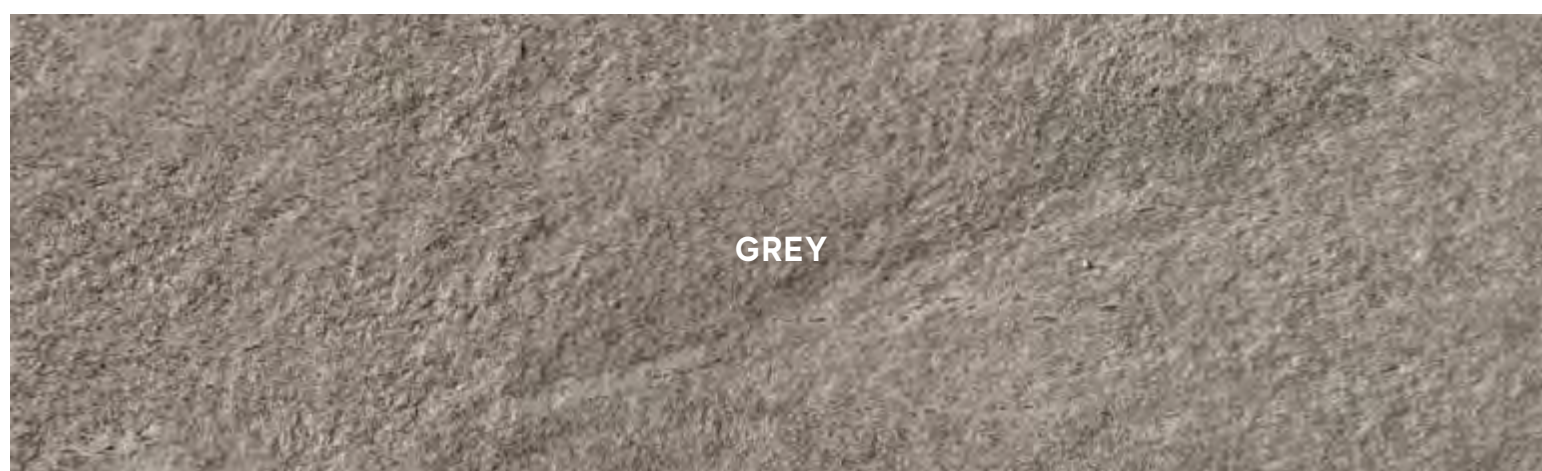

GREY

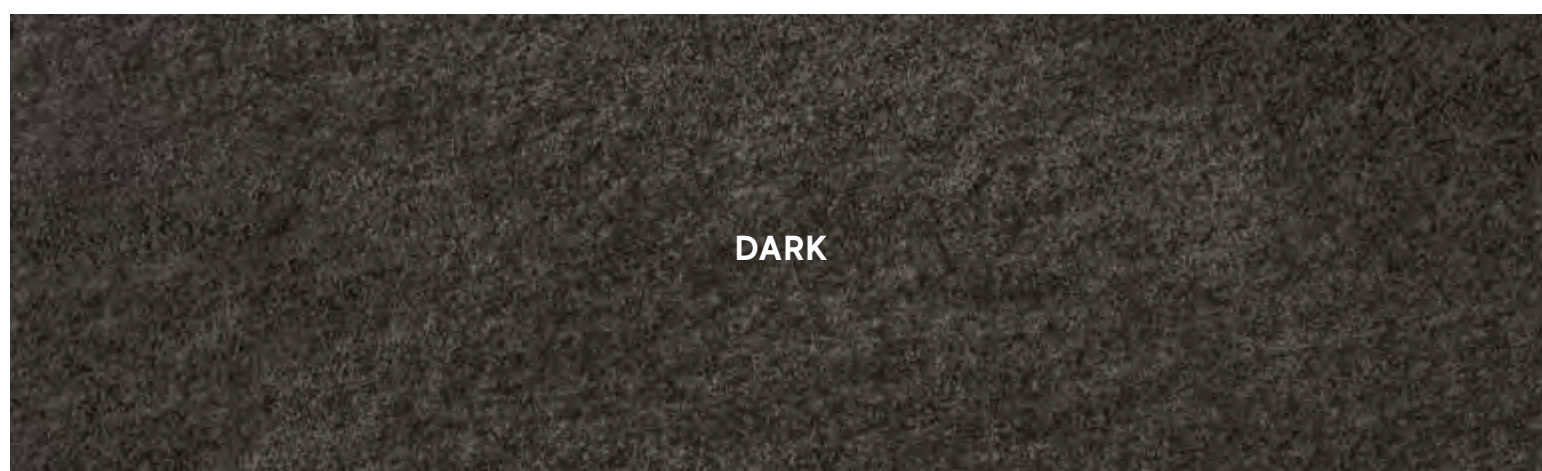

DARK

KLIF Porcelain tiles

COLOURED BODY PORCELAIN TILES - RECTIFIED MONOCALIBER

GRES PORCELLANATO COLORATO IN MASSA - RETTIFICATO MONOCALIBRO

Grès cérame coloré dans la masse - Rectifié mono-calibre / Durchgefärbtes Feinsteinzeug - Geschliffen einkalibrig

Gres porcelánico coloreado en masa - Rectificado monocalibre / Керамический гранит окрашенный в массе - Ретифицированный в одном калибре

Sizes and surfaces / Formati e superfici

MATTE / MATT

MAT / MATT / MATE / МАТОВАЯ

75x150 cm - 29¹/₂"x59" ± 9 mm

75x75 cm - 29¹/₂"x29¹/₂" ± 9 mm

37,5x75 cm - 14³/₄"x29¹/₂" ± 9 mm

GRIP / GRIP

GRIP / GRIP / GRIP / МАТОВАЯ

37,5x75 cm - 14³/₄"x29¹/₂" ± 9 mm

OUTDOOR PAVING / PAVIMENTI DA ESTERNO

SOLS D'EXTÉRIEUR / BODENBELÄGE FÜR AUSSENBEREICHE /

PAVIMENTOS PARA EXTERIORES / УЛИЧНАЯ ПЛИТКА

90x90 cm - 35³/₈"x35³/₈" ± 20 mm *

45x90 cm - 17³/₄"x35³/₈" ± 20 mm *

60x60 cm - 23⁵/₈"x23⁵/₈" ± 20 mm *

Available in / Disponibile in:

- * Silver, Grey, Dark

Porcelain tiles ± 20 mm

For further details on the 20mm thick products, related trim pieces and installation systems - in particular for recommendations and precautions during installation - please refer to the Outdoor Design section on the Atlas Concorde website or to the Outdoor Design catalogue. / Per dettagli sul prodotto e sui relativi pezzi speciali in 20mm di spessore, per i sistemi di posa e, in particolare, per raccomandazioni, accorgimenti e precauzioni in fase di posa e progettazione, si raccomanda di prendere visione del catalogo Outdoor Design e della sezione Outdoor Design del sito Atlas Concorde.



R10
A+B

H
HEAVY
TRAFFIC



R11
A+B+C

H
HEAVY
TRAFFIC



R11
A+B+C

H
HEAVY
TRAFFIC

Color-shading Stonalizzazione

White, Silver,
Grey, Dark



V3 MODERATE
VARIATION

KLIF

Porcelain tile decors

Klif White Mosaico
30x30 cm - 11³/₄"x11³/₄"



Klif Silver Mosaico
30x30 cm - 11³/₄"x11³/₄"

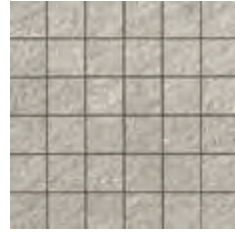

Klif Grey Mosaico
30x30 cm - 11³/₄"x11³/₄"

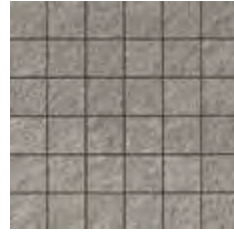

Klif Dark Mosaico
30x30 cm - 11³/₄"x11³/₄"

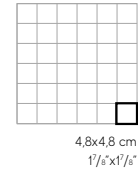

Klif White Triangles
28,5x33 cm - 11¹/₄"x13"



Klif Silver Triangles
28,5x33 cm - 11¹/₄"x13"



Klif Grey Triangles
28,5x33 cm - 11¹/₄"x13"



Klif Dark Triangles
28,5x33 cm - 11¹/₄"x13"

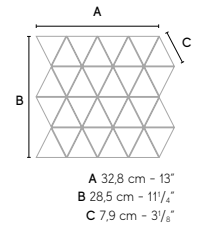

KLIF
Porcelain tile decors

Klif White Brick
37,5x75 cm - 14³/₄"x29¹/₂"



Klif Silver Brick
37,5x75 cm - 14³/₄"x29¹/₂"



Klif Grey Brick
37,5x75 cm - 14³/₄"x29¹/₂"



Klif Dark Brick
37,5x75 cm - 14³/₄"x29¹/₂"



Klif White Brick 3D
28x55cm - 11"x21⁵/₈"



Klif Silver Brick 3D
28x55cm - 11"x21⁵/₈"



Klif Grey Brick 3D
28x55cm - 11"x21⁵/₈"



Klif Dark Brick 3D
28x55cm - 11"x21⁵/₈"

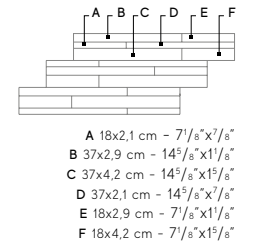
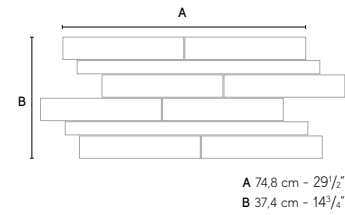

KLIF

Wall tiles

WHITEBODY WALL TILES - RECTIFIED MONOCALIBER

RIVESTIMENTI IN PASTA BIANCA - RETTIFICATO MONOCALIBRO

Revêtements en pâte blanche - Rectifié mono-calibre / Weißscherbige Wandfliesen - Geschliffen einkalbrig

Revestimientos en pasta blanca - Rectificado monocalibre / Настенная плитка из белой глины - Ретифицированный в одном калибре

Sizes and surfaces / Formati e superfici

MATTE / MATT
MAT / MATT / MATE / MATOBAЯ

40x80 cm - 15³/₄"x31¹/₂" ± 8,5 mm

Klif White
40x80 cm - 15³/₄"x31¹/₂"

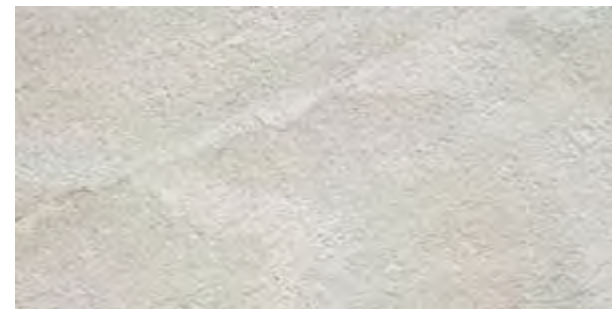

Klif Silver
40x80 cm - 15³/₄"x31¹/₂"

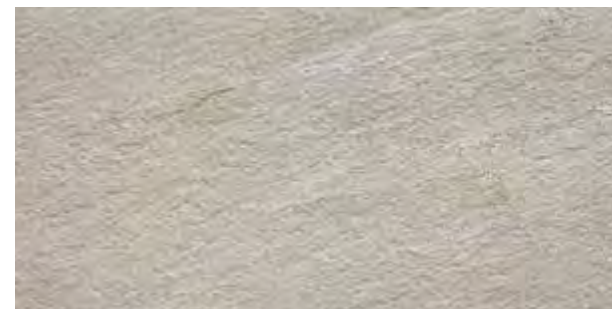

Klif Grey
40x80 cm - 15³/₄"x31¹/₂"

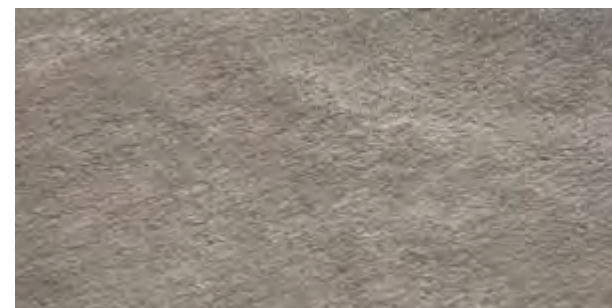

MATTE / MATT
MAT / MATT / MATE / MATOBAЯ

3D Row 40x80 cm - 15³/₄"x31¹/₂" ± 10 mm



Klif 3D Row White
40x80 cm - 15³/₄"x31¹/₂"



Klif 3D Row Silver
40x80 cm - 15³/₄"x31¹/₂"



Klif 3D Row Grey
40x80 cm - 15³/₄"x31¹/₂"



Color-shading Stonalizzazione

White, Silver, Grey



V2 SLIGHT
VARIATION



KLIF

Porcelain trim tiles

INDOOR TRIM TILES

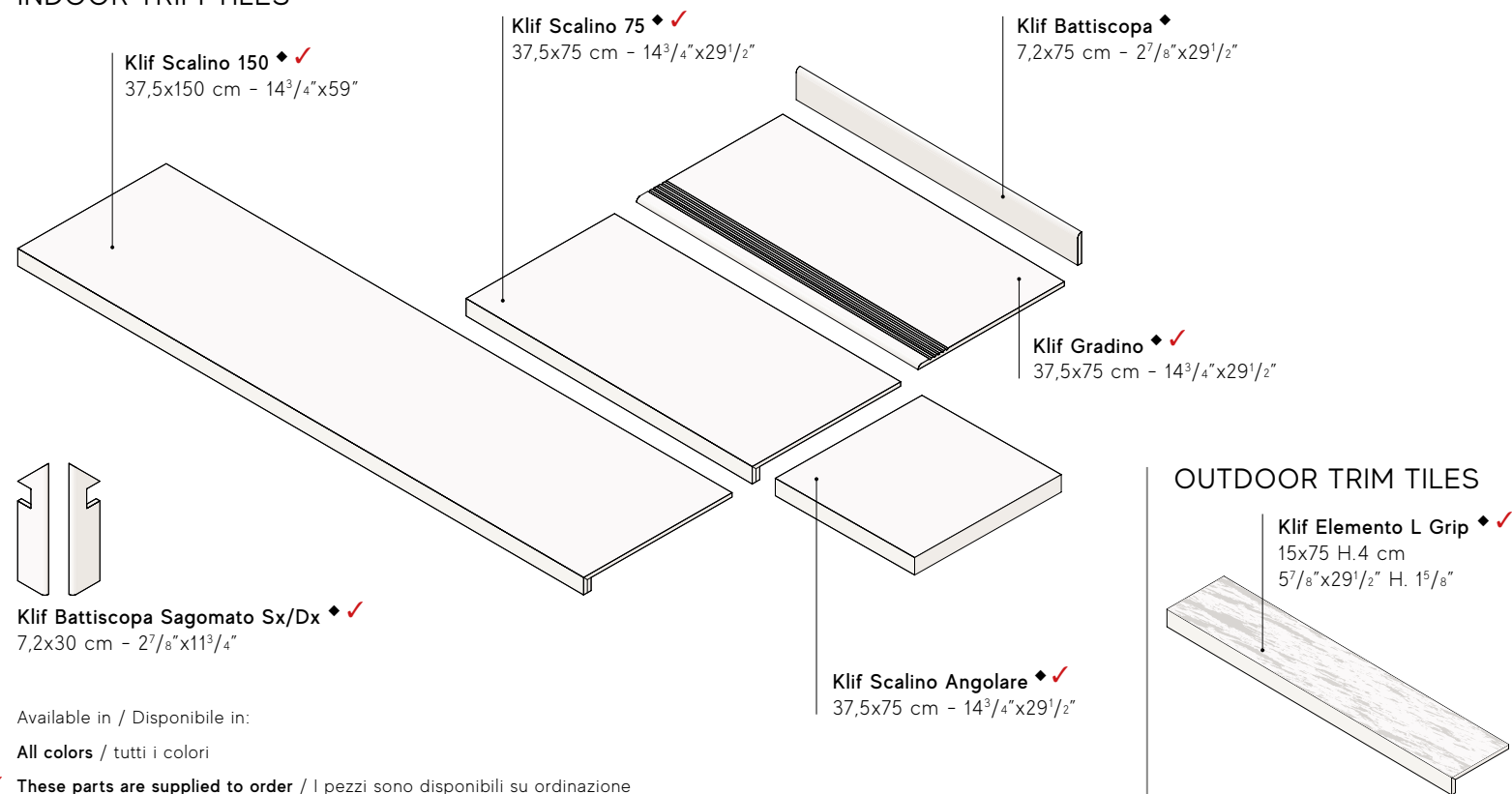

OUTDOOR TRIM TILES

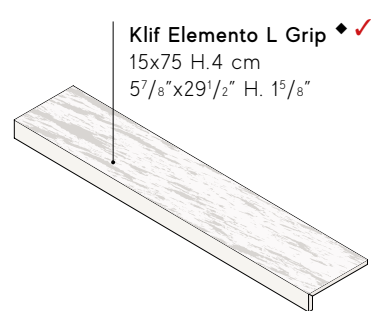

Outdoor trim tiles ± 20 mm

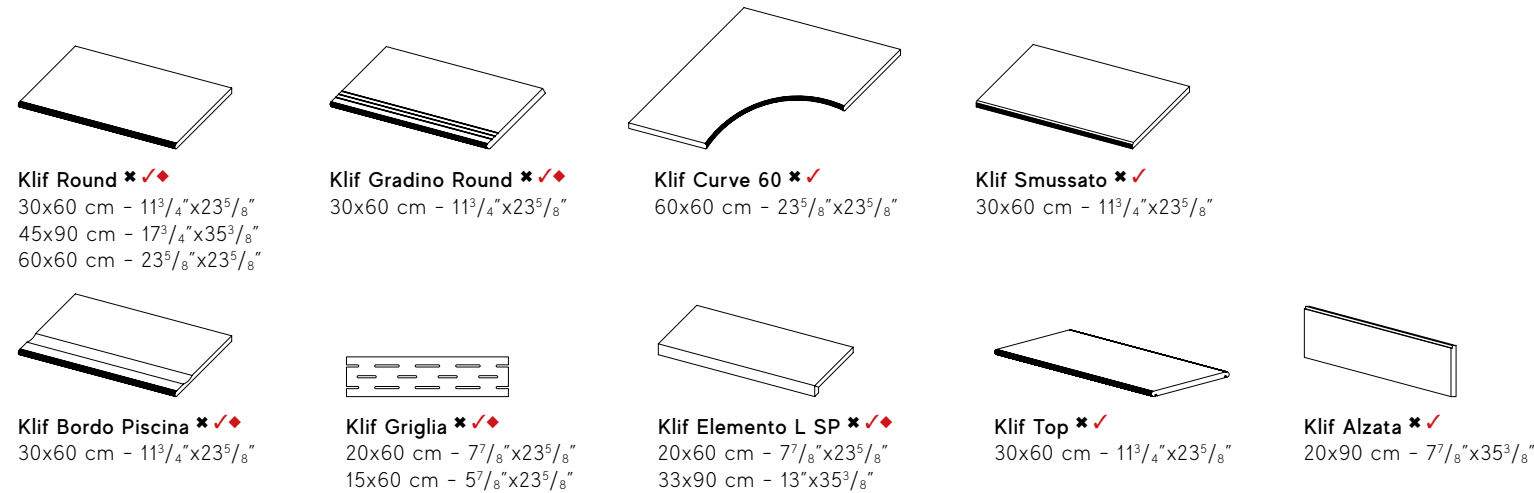

Wall trim tiles

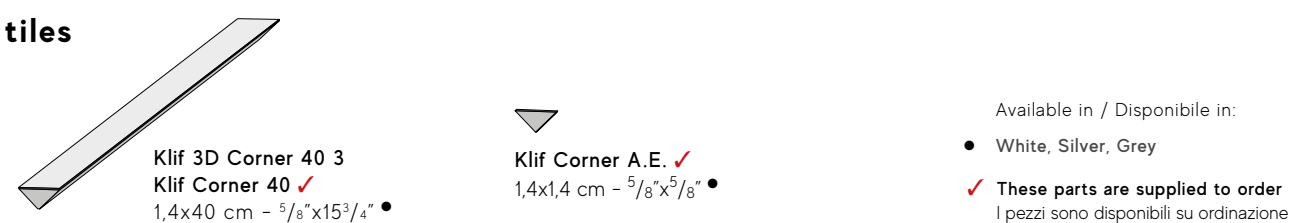

Note

For information and details relating to codes, packaging and weight it is recommended to refer to the latest pricelist. / Per le informazioni e i dati relativi a codici, imballaggi e pesi occorre sempre consultare l'ultimo listino aggiornato e in vigore. / Para acceder a la información y a los datos relativos a códigos, embalajes y pesos hay que consultar siempre la última lista de precios actualizada y vigente. / Für Informationen und Daten die den Code, die Verpackung und das Gewicht betreffen bitte die aktuellste Preisliste zugrunde legen. / Pour toutes informations et renseignements concernant les codes, les emballages et les poids, il y a toujours lieu de consulter le dernier tarif en vigueur et mis à jour. / Для информации о кодах, упаковках и весе обращайтесь к последнему действующему прайс-листу.

Colors and optical features of the materials illustrated in this catalogue are to be regarded as mere indications. / I colori e le caratteristiche estetiche dei materiali illustrati nel presente catalogo sono da ritenersi puramente indicativi. / Los colores y las características estéticas de los materiales ilustrados en el presente catálogo deben ser considerados como puramente indicativos. / Die Farben und die ästhetischen Eigenschaften der in diesem Katalog abgebildeten Produkte sind als reine Richtwerte zu betrachten. / Les coloris et les caractéristiques esthétiques des références illustrées dans le catalogue sont donnés à titre purement indicatif. / Цвета и эстетические характеристики описанных в настоящем каталоге материалов являются только ориентировочными.

Atlas Concorde reserves the right to modify any product without notice and will not be liable for any direct or indirect damage resulting from such modifications. / Atlas Concorde si riserva di modificare i prodotti senza preavviso, declinando ogni responsabilità su eventuali danni diretti o indiretti derivanti da eventuali modifiche. / Atlas Concorde se reserva el derecho de modificar los productos sin previo aviso, rechaza cualquier responsabilidad sobre eventuales daños directos o indirectos derivados de eventuales modificaciones. / Atlas Concorde behält sich das Recht vor jederzeit und ohne vorherige Ankündigung, die Produkte zu verändern, und lehnt jede Haftung bei direkten oder indirekten Schäden ab, die von diesen Veränderungen herrühren. / Atlas Concorde se réserve le droit de modifier ses produits sans préavis et décline toute responsabilité concernant les éventuels dommages directs ou indirects qui pourraient dériver de ces modifications. / Atlas Concorde оставляет за собой право изменять характеристики изделий без предварительного уведомления, отклоняя при этом любую ответственность за прямые или косвенные убытки, возникшие в результате изменений.

THANKS TO

cielo
handmade in Italy
www.ceramicacielo.it

prandina
LIGHTING STORIES
www.prandina.it

Billiani
1911
www.billiani.it

NEVE
www.neve-rubinetterie.it

ALICE
CERAMICA
www.aliceceramica.com

Frag
dal 1921
www.frag.it

IC
IGONE
www.iconeluce.com

CERAMIC AND PORCELAIN TILES: A SAFE CHOICE

RESISTANCE AND DURATION

RESISTENZA E DURATA

Easy to maintain

Facile da mantenere



Porcelain tiles do not require any special maintenance.

Il gres porcellanato non richiede manutenzioni particolari.

UV Resistant

Resistente ai raggi UV



Porcelain tiles maintain their colors even when exposed to continuous, direct sunlight or in contact with atmospheric agents or smog.

Il gres porcellanato rimane inalterato nei suoi colori anche se esposto alla luce diretta e continua del sole o a contatto con agenti atmosferici o smog.

Scratch resistant

Resistente al graffio



Porcelain tiles do not splinter, break or get damaged.

Il gres porcellanato non si scheggia, non si rompe e non si danneggia.

Easy to clean

Facile da pulire



Porcelain tiles are easy to clean.

Il gres porcellanato si pulisce facilmente.

Waterproof

Resistente all'acqua



Porcelain tiles are completely non-porous and therefore are not damaged by water or humidity.

Il gres porcellanato è completamente non poroso e non teme l'acqua e l'umidità.

Stain resistant

Resistente alle macchie

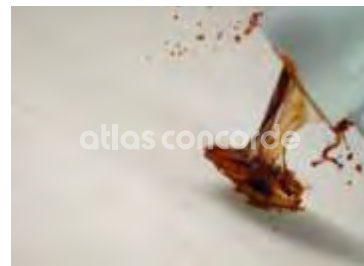

Porcelain tiles are waterproof, no liquid can damage the surface.

Il gres porcellanato è impermeabile e nessun tipo di liquido può danneggiarne la superficie.

Resistant to chemicals

Resistente agli agenti chimici



Porcelain tiles do not stain and resist the most aggressive chemical agents.

Il gres porcellanato non si macchia e resiste agli agenti chimici più aggressivi.

Resistant to acids

Resistente agli acidi



Porcelain tiles are resistant to acids found in food and cleaning products.

Il gres porcellanato resiste agli acidi di uso alimentare e domestico.

Resistant to thermal shock

Resistente agli shock termici



A porcelain tile floor will not change as a result of sharp temperature fluctuations.

Un pavimento in gres porcellanato non si altera a causa di sbalzi termici.

Frost resistant

Resistente al ghiaccio



Porcelain tiles are frost resistant and therefore are not damaged by low temperatures.

Il gres porcellanato è ingelivo e resiste alle temperature più basse.

HEALTH

SALUTE

Zero VOCS

Zero VOC



Porcelain tiles are intrinsically inorganic and do not emit volatile organic compounds (VOC).

Le piastrelle in gres porcellanato sono intrinsecamente inorganiche e non emettono composti organici volatili.

Zero PVC

Zero PVC



Porcelain tiles contain no PVC, plastics or petroleum derivatives.

Il gres porcellanato è privo di PVC, plastiche o derivati del petrolio.

Zero formaldehyde

Zero formaldeide



Porcelain tiles do not contain formaldehyde.

Il gres porcellanato non contiene formaldeide.

Zero allergens

Zero allergeni



Porcelain tiles are inhospitable for mites, bacteria, fungi, molds, and other irritants.

Il gres porcellanato è inospitale per acari, batteri, funghi, muffe e altre sostanze irritanti.

Prevent bacterial growth

Previene la crescita batterica

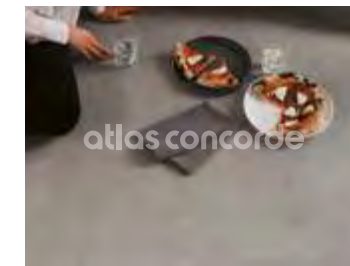

Porcelain tiles are completely hygienic and inhospitable for bacteria, mites, molds, and fungi.

Il gres porcellanato è assolutamente igienico e inospitale per i batteri, acari, muffe e funghi.

SAFETY

SICUREZZA

Non-slip

Antiscivolo



Porcelain tile surfaces can be made with an abrasive surface grit that can increase traction and reduce the risk of slipping.

Le superfici in gres porcellanato possono essere realizzate con una graniglia abrasiva superficiale in grado di aumentare la trazione e ridurre i rischi di scivolamento.

Fire resistant

Resistente al fuoco



Porcelain tiles are not flammable, reduce the spread of flames, do not burn, and do not emit toxic fumes.

Le piastrelle in gres porcellanato non sono infiammabili, riducono la propagazione della fiamma, non bruciano e non emettono fumi tossici.

Heat resistant

Resistente al calore



Porcelain tiles do not change shape at high temperatures.

Il gres porcellanato non si altera alle alte temperature.

ENVIRONMENT

AMBIENTE

Energy efficiency

Efficienza energetica



The high thermal inertia of porcelain tiles moderates the changes in temperature of the rooms, favoring energy savings.

L'elevata inerzia termica del gres porcellanato modera gli sbalzi di temperatura degli ambienti, favorendo il risparmio energetico.

Ecological

Ecologico



Porcelain tiles have a low environmental impact at all stages of their production, from the raw materials to disposal and recycling.

Il gres porcellanato ha un basso impatto ambientale in tutte le fasi del suo processo industriale, dalle materie prime fino allo smaltimento e al riciclo.

Recycling and re-use

Riciclo e riutilizzo



Porcelain tiles are made with recycled materials, last a long time, and can be re-used because they retain their original appearance.

Il gres porcellanato è realizzato con materiali di riciclo, dura a lungo e mantenendo l'aspetto originario può essere riciclato.

Ideal for floor heating systems

Ideale per sistemi di riscaldamento a pavimento



Porcelain tiles can be effectively combined with floor heating systems.

Il gres porcellanato può essere abbinato in modo efficace a sistemi di riscaldamento a pavimento.

WALL TILES ADDITIONAL BENEFITS

PROPRIETÀ CERAMICA
DA RIVESTIMENTO

Ease of installation

Facilità di lavorazione



Cuts, holes, and bevels are easily made and reduce the time it takes to lay the white body tiles.

Tagli, fori, bisellature sono facili da realizzare e rendono più veloce la posa dei rivestimenti in pasta bianca.

Extremely easy to clean

Estrema facilità di pulizia



White body ceramic tiles can be cleaned with a simple passage of hot water or neutral detergent.

I rivestimenti ceramici in pasta bianca si puliscono con un semplice passaggio di acqua calda o detergente neutro.

While porcelain tiles are ideal for use on the floor thanks to their hardness and extreme durability, the light weight and workability of white body tiles make them ideal for use on walls: cuts and holes can be made quickly and easily, reducing installation time and costs.

Mentre il gres porcellanato è ideale per l'uso a pavimento, per la sua durezza e l'estrema resistenza, le caratteristiche di leggerezza e lavorabilità del rivestimento in pasta bianca lo rendono ideale per l'uso a parete: i tagli e i fori saranno eseguiti facilmente e velocemente, riducendo i tempi e i costi di posa.



LE GRÈS CÉRAME : LE CHOIX SÛR / DAS FEINSTEINZEUG: EINE SICHERE WAHL / GRES PORCELÁNICO: LA ELECCIÓN SEGURA / КЕРАМИКА: НАДЕЖНЫЙ ВЫБОР

Résistance et longévité / Widerstandsfähigkeit und Lebensdauer / Resistencia y durabilidad / Стойкость и долговечность

Résistance et longévité / Widerstandsfähigkeit und Lebensdauer / Resistencia y durabilidad / Стойкость и долговечность

Entretien facile / Leicht zu warten / Fácil de mantener / Простота ухода

Entretien facile / Leicht zu warten / Fácil de mantener / Простота ухода

Le grès cérame n'exige aucun entretien particulier. / Feinsteinzeug erfordert keine besonderen Wartungsarbeiten. / El gres porcelánico no requiere particulares operaciones de mantenimiento. / Керамогранит не нуждается в особом уходе.

Résistant aux rayons UV / UV-Strahlenfest / Resistente a los rayos UV / Стойкость к УФ-излучению

Résistant aux rayons UV / UV-Strahlenfest / Resistente a los rayos UV / Стойкость к УФ-излучению

Les coloris du grès cérame restent inaltérés même s'il est exposé à la lumière directe et continue du soleil ou au contact du smog et des agents atmosphériques. / Die Farben des Feinsteinzeugs bleiben unverändert erhalten, auch wenn es direktem und ständigem Sonnenlicht, der Witterung oder Smog ausgesetzt ist. / El gres porcelánico no se altera con el paso del tiempo, tampoco cambia su color cuando está expuesto a la luz directa y continua del sol o cuando entra en contacto con agentes climatológicos o contaminación. / Керамогранит не выцветает даже при постоянном воздействии солнечного света, атмосферных факторов, смога.

Résistant aux rayures / Kratzfestigkeit / Resistente a las rayas / Стойкость к царапинам

Résistant aux rayures / Kratzfestigkeit / Resistente a las rayas / Стойкость к царапинам

Le grès cérame ne subit ni ébréchures, ni cassures, ni dommages. / Feinsteinzeug splittert nicht, es zerbricht nicht und erleidet keine Beschädigungen. / El gres porcelánico no se desportilla, no se rompe y no se estropea. / Керамогранит не раскалывается, не ломается, не повреждается.

Facile à nettoyer / Leicht zu reinigen / De fácil limpieza / Легкость чистки

Facile à nettoyer / Leicht zu reinigen / De fácil limpieza / Легкость чистки

Le grès cérame se nettoie facilement. / Feinsteinzeug kann leicht gereinigt werden. / El gres porcelánico se limpia fácilmente. / Керамогранит легко очищается.

Résistant aux taches / Fleckenfestigkeit / Resistente a las manchas / Стойкость к пятнам

Résistant aux taches / Fleckenfestigkeit / Resistente a las manchas / Стойкость к пятнам

Le grès cérame est imperméable et aucun type de liquide ne peut endommager sa surface. / Feinsteinzeug ist wasserundurchlässig und Flüssigkeiten jeglicher Art können seine Oberfläche nicht beschädigen. / El gres porcelánico es impermeable y ningún tipo de líquido puede estropear la superficie. / Керамогранит непроницаем, и никакая жидкость не может повредить его поверхность.

Résistant aux agents chimiques / Beständigkeit gegen Chemikalien / Resistente a los agentes químicos / Стойкость к химическим веществам

Le grès cérame ne se tache pas et résiste aux agents chimiques les plus agressifs. / Feinsteinzeug ist fleckenfest und beständig gegen die aggressivsten Chemikalien. / El gres porcelánico no se mancha y es resistente a los agentes químicos más agresivos. / Даже самые агрессивные химикаты не повреждают керамогранит и не оставляют на нем пятен.

Résistant aux acides / Beständigkeit gegen Säuren / Resistente a los ácidos / Стойкость к кислотам

Résistant aux acides / Beständigkeit gegen Säuren / Resistente a los ácidos / Стойкость к кислотам

Le grès cérame résiste aux acides d'usage alimentaire et domestique. / Feinsteinzeug ist beständig gegen Säuren, die in Nahrungsmitteln oder im Haushalt verwendet werden. / El gres porcelánico es resistente a los ácidos de uso alimenticio y doméstico. / Керамогранит устойчив к кислотам, входящим в состав пищевых продуктов и средств бытовой химии.

Résistant aux écarts thermiques / Beständigkeit gegen thermoschocks / Resistente a los choques térmicos / Стойкость к перепадам температур

Résistant aux écarts thermiques / Beständigkeit gegen thermoschocks / Resistente a los choques térmicos / Стойкость к перепадам температур

Résistant à l'eau / Wasserfestigkeit / Resistente al agua / Стойкость к воде

Résistant à l'eau / Wasserfestigkeit / Resistente al agua / Стойкость к воде

Résistant au gel / Frostbeständigkeit / Resistente a las heladas / Стойкость к морозам

Le grès cérame est absolument non poreux et ne craint ni l'eau ni l'humidité. / Feinsteinzeug ist absolut porös und fürchtet weder Wasser noch Feuchtigkeit. / El gres porcelánico no es poroso, no le penetra el agua y es resistente a la humedad. / Керамогранит – абсолютно непористый материал, поэтому не боится воды и влаги.

Résistant au gel / Frostbeständigkeit / Resistente a las heladas / Стойкость к морозам

Résistant au gel / Frostbeständigkeit / Resistente a las heladas / Стойкость к морозам

Résistant au gel / Frostbeständigkeit / Resistente a las heladas / Стойкость к морозам

Le grès cérame est absolument non poreux et ne craint ni l'eau ni l'humidité. / Feinsteinzeug ist absolut porös und fürchtet weder Wasser noch Feuchtigkeit. / El gres porcelánico no es poroso, no le penetra el agua y es resistente a la humedad. / Керамогранит – абсолютно непористый материал, поэтому не боится воды и влаги.

Résistant au gel / Frostbeständigkeit / Resistente a las heladas / Стойкость к морозам

Résistant au gel / Frostbeständigkeit / Resistente a las heladas / Стойкость к морозам

Le grès cérame est ingélif et résiste aux températures les plus basses. / Feinsteinzeug ist frostbeständig und widersteht den niedrigsten Temperaturen. / El gres porcelánico es resistente a las heladas y a las bajas temperaturas. / Керамогранит способен противостоять морозам и низким температурам.

Santé / Gesundheit / Salud / Здоровье

Santé / Gesundheit / Salud / Здоровье

Zéro allergène / Null allergene / Cero alérgenos / Ноль аллергенов

Zéro allergène / Null allergene / Cero alérgenos / Ноль аллергенов

Le grès cérame est inhospitalier vis-à-vis des acariens, bactéries, champignons, moisissures et autres substances irritantes. / Feinsteinzeug ist unangstlich für Milben, Bakterien, Pilze, Schimmel und andere Reizstoffe. / El gres porcelánico es inhóspito para los ácaros, bacterias, hongos, mohos y otras sustancias irritantes. / На поверхности керамогранита не накапливаются клещи, бактерии, грибки, плесень и другие болезнетворные микроорганизмы.

Zéro COV / Null VOC / Cero VOC / Ноль летучих органических соединений

Zéro COV / Null VOC / Cero VOC / Ноль летучих органических соединений

Les carreaux en grès cérame sont intrinsèquement inorganiques et ne libèrent aucun composé organique volatil. / Feinsteinzeugfliesen sind von Natur aus anorganisch und setzen keine flüchtigen organischen Verbindungen frei. / Las baldosas de gres porcelánico son intrínsecamente inorgánicas y no emiten compuestos orgánicos volátiles. / Керамогранит является неорганическим материалом и не выделяет летучих органических соединений.

Zéro formaldéhyde / Null formaldehyd / Cero formaldehído / Ноль формальдегида

Zéro formaldéhyde / Null formaldehyd / Cero formaldehído / Ноль формальдегида

Le grès cérame ne contient pas de formaldéhyde. / Feinsteinzeug ist formaldehydfrei. / El gres porcelánico non contiene formaldehído. / Керамогранит не содержит формальдегид.

Zéro PVC / Null PVC / Cero PVC / Ноль ПВХ

Le grès cérame est privé de PVC, de matières plastiques et de dérivés du pétrole. / Feinsteinzeug ist frei von PVC, Kunststoffen oder Petroleumderivaten. / El gres porcelánico no contiene PVC, plástico o sustancias que derivan del petróleo. / Керамогранит не содержит ПВХ, пластиковых материалов, нефтепродуктов.

Prévention de la croissance bactérienne / Vorbeugung gegen das Wachstum von Bakterien / Previene la proliferación de bacterias / Предотвращение развития бактерий

Il prévient la croissance bactérienne / Vorbeugung gegen das Wachstum von Bakterien / Previene la proliferación de bacterias / Предотвращение развития бактерий

Le grès cérame est absolument hygiénique et inhospitalier vis-à-vis des bactéries, acariens, moisissures et champignons. / Feinsteinzeug ist absolut hygienisch und unangstlich für Bakterien, Milben, Schimmel und Pilze. / El gres porcelánico es totalmente higiénico e inhóspito para las bacterias, ácaros, mohos y hongos. / Керамогранит абсолютно гигиеничен и препятствует развитию бактерий, клещей, плесени, грибка.

Sécurité / Sicherheit / Seguridad / Безопасность

Sécurité / Sicherheit / Seguridad / Безопасность

Sécurité / Sicherheit / Seguridad / Безопасность

Antiglisse / Rutschfestigkeit / Antideslizante / Препятствование скольжению

Antiglisse / Rutschfestigkeit / Antideslizante / Препятствование скольжению

Les surfaces en grès cérame peuvent être réalisées avec un fond superficiel abrasif en mesure d'augmenter la traction et réduire le risque de glissade. / Die Oberflächen des Feinsteinzeugs können mit die Reibung erhöhenden Splitten bereichert werden, welche die Trittsicherheit verbessern und die Gefahr von Ausrutschern mindern. / Las superficies de gres porcelánico se fabrican con una granalla abrasiva superficial en grado de aumentar la tracción y reducir los riesgos de deslizamiento. / На поверхность керамогранитной плитки в процессе изготовления может наноситься специальная абразивная крошка, которая увеличивает сцепление и снижает риск скольжения.

Les surfaces en grès cérame peuvent être réalisées avec un fond superficiel abrasif en mesure d'augmenter la traction et réduire le risque de glissade. / Die Oberflächen des Feinsteinzeugs können mit die Reibung erhöhenden Splitten bereichert werden, welche die Trittsicherheit verbessern und die Gefahr von Ausrutschern mindern. / Las superficies de gres porcelánico se fabrican con una granalla abrasiva superficial en grado de aumentar la tracción y reducir los riesgos de deslizamiento. / На поверхность керамогранитной плитки в процессе изготовления может наноситься специальная абразивная крошка, которая увеличивает сцепление и снижает риск скольжения.

Résistant au feu / Feuerfestigkeit / Resistente al fuego / Огнестойкость

Résistant au feu / Feuerfestigkeit / Resistente al fuego / Огнестойкость

Les carreaux en grès cérame sont ininflammables, ils réduisent la propagation de la flamme, ne brûlent pas et de libèrent aucune fumée toxique. / Feinsteinzfliesen sind nicht entflammbar, sie mindern die Flammenausbreitung, brennen nicht und setzen keinen toxischen Rauch frei. / Las baldosas de gres porcelánico no son inflamables, reducen la propagación de las llamas, son resistentes al fuego y no emiten humos tóxicos. / Керамогранитная плитка не воспламеняется, ограничивает распространение огня, не горит, не выделяет токсичного дыма.

Les carreaux en grès cérame sont ininflammables, ils réduisent la propagation de la flamme, ne brûlent pas et de libèrent aucune fumée toxique. / Feinsteinzfliesen sind nicht entflammbar, sie mindern die Flammenausbreitung, brennen nicht und setzen keinen toxischen Rauch frei. / Las baldosas de gres porcelánico no son inflamables, reducen la propagación de las llamas, son resistentes al fuego y no emiten humos tóxicos. / Керамогранитная плитка не воспламеняется, ограничивает распространение огня, не горит, не выделяет токсичного дыма.

Résistant à la chaleur / Wärmebeständigkeit / Resistente al calor / Термостойкость

Résistant à la chaleur / Wärmebeständigkeit / Resistente al calor / Термостойкость

Le grès ne subit aucune altération aux températures élevées. / Feinsteinzeug wird von hohen Temperaturen nicht verändert. / El gres porcelánico no se altera con las altas temperaturas. / Керамогранит не повреждается под действием высоких температур.

Environnement / Umwelt / Ambiente / Окружающая среда

Efficacité énergétique / Energieeffizienz / Eficiencia energética / Энергоэффективность

Efficacité énergétique / Energieeffizienz / Eficiencia energética / Энергоэффективность

La haute inertie thermique du grès cérame modère les écarts de température à l'intérieur des pièces, en favorisant ainsi les économies d'énergie. / Die hohe Wärmeträgheit des Feinsteinzeugs reduziert starke Temperaturschwankungen in den Räumen und ermöglicht demzufolge eine Energieeinsparung. / La elevada inercia térmica del gres porcelánico modera los cambios de temperatura de los ambientes, favoreciendo el ahorro energético. / Высокая тепловая инерция керамогранита сглаживает колебания температуры в помещении, что позволяет значительно экономить энергию.

La haute inertie thermique du grès cérame modère les écarts de température à l'intérieur des pièces, en favorisant ainsi les économies d'énergie. / Die hohe Wärmeträgheit des Feinsteinzeugs reduziert starke Temperaturschwankungen in den Räumen und ermöglicht demzufolge eine Energieeinsparung. / La elevada inercia térmica del gres porcelánico modera los cambios de temperatura de los ambientes, favoreciendo el ahorro energético. / Высокая тепловая инерция керамогранита сглаживает колебания температуры в помещении, что позволяет значительно экономить энергию.

Écologique / Ökologisch / Ecológico / Экологичность

Écologique / Ökologisch / Ecológico / Экологичность

Le grès cérame a un faible impact sur l'environnement durant toutes les phases de son processus industriel, à partir des matières premières jusqu'à l'élimination et au recyclage. / In allen Phasen seines Herstellungsprozesses verursacht das Feinsteinzeug eine geringfügige Umweltbelastung, angefangen beim Abbau der Rohstoffe bis zur Entsorgung und zum Recycling. / El gres porcelánico tiene un bajo impacto ambiental en todas las fases de su proceso industrial, dese las materias primas hasta la eliminación y el reciclaje. / Керамогранит имеет низкое воздействие на окружающую среду на всем протяжении жизненного цикла: от добычи сырья до переработки и утилизации.

Recyclage et réutilisation / Recycling und wiederverwertung / Reciclaje y reutilización / Переработка и утилизация

Recyclage et réutilisation / Recycling und wiederverwertung / Reciclaje y reutilización / Переработка и утилизация

Le grès cérame est fabriqué avec des matériaux de recyclage, il dure longtemps en maintenant son aspect d'origine et il est recyclable. / Feinsteinzeug wird aus Recycling-Material hergestellt, hat eine lange Lebensdauer, erhält sein ursprüngliches Aussehen und kann recycelt werden. / El gres porcelánico está fabricado con materiales de reciclado, es duradero al paso del tiempo y se puede reciclar manteniendo el aspecto original. / Керамогранит изготавливается из переработанных материалов, долговечен, сохраняет во времени свои первоначальные характеристики и поддается переработке.

Idéal pour les systèmes de chauffage au sol / Ideal für fussbodenheizsysteme / Indicado para los sistemas de calefacción por suelo radiante / Идеальное решение для теплого пола

Idéal pour les systèmes de chauffage au sol / Ideal für fussbodenheizsysteme / Indicado para los sistemas de calefacción por suelo radiante / Идеальное решение для теплого пола

Le grès cérame peut être associé de manière efficace à des systèmes de chauffage au sol. / Feinsteinzeug ist optimal leistungsfähig in Verbindung mit Fußbodenheizsystemen. / El gres porcelánico se puede utilizar eficazmente con sistemas de calefacción por suelo radiante. / Керамогранит отлично подходит для облицовки полов с подогревом.

PROPRIÉTÉS DE LA CÉRAMIQUE POUR REVÊTEMENTS / EIGENSCHAFTEN DER WANDFLIESEN / CARACTERÍSTICAS Y BENEFICIOS DE LA CERÁMICA PARA REVESTIMIENTO / СВОЙСТВА КЕРАМИЧЕСКОЙ ПЛИТКИ

Tandis que le grès cérame est idéal pour l'usage au sol en raison de sa dureté et de son extrême résistance, les caractéristiques de légèreté et d'usinabilité des carreaux en pâte blanche en font l'idéal pour l'usage mural : les découpes et les perçages s'effectuent facilement et rapidement, en réduisant les temps et les coûts de la pose. / Während das Feinsteinzeug dank seiner Härte und extremen Widerstandsfähigkeit ideal für die Fußbodenverlegung ist, machen die Leichtigkeit und die Verarbeitungsfreundlichkeit der weißscherbigen Wandbeläge diese ideal für Wandverlegungen: Schnitte und Bohrungen werden leicht und schnell ausgeführt, wodurch die Verlegungszeiten und -kosten sich verringern. / Si bien el gres porcelánico es indicado para su uso en pavimentos, por su dureza y máxima resistencia, el revestimiento de pasta blanca es indicado para su uso en paredes por sus propiedades de ligereza y facilidad de trabajo: se consigue una mejor facilidad y rapidez de cortes y perforación, reduciendo los tiempos y costes de colocación. / Если керамогранит, в силу своей твердости и стойкости, особенно рекомендован для полов, то такие характеристики, как небольшой вес и высокая обрабатываемость, делают плитку из белой глины идеальной для монтажа на стену: легкость и быстрота резки и сверления снижают затраты времени и денег на укладку.

Facilité de travail / Verarbeitungsfreundlichkeit / Fácil de trabajar / Легкость обработки

Facilité de travail / Verarbeitungsfreundlichkeit / Fácil de trabajar / Легкость обработки

Les découpes, les perçages et les biseautages sont faciles à réaliser et rendent plus rapide la pose des carrelages en pâte blanche. / Schnitte, Bohrungen, Abkantungen sind leicht zu verwirklichen, daher können weißscherbige Keramikbeläge überall schneller verlegt werden. / Cortes, perforaciones y biselados se realizan fácilmente y la instalación de los revestimientos de pasta blanca se hace con rapidez. / Легкость резки, сверления, скашивания граней ускоряет процесс укладки настенной плитки из белой глины.

Les découpes, les perçages et les biseautages sont faciles à réaliser et rendent plus rapide la pose des carrelages en pâte blanche. / Schnitte, Bohrungen, Abkantungen sind leicht zu verwirklichen, daher können weißscherbige Keramikbeläge überall schneller verlegt werden. / Cortes, perforaciones y biselados se realizan fácilmente y la instalación de los revestimientos de pasta blanca se hace con rapidez. / Легкость резки, сверления, скашивания граней ускоряет процесс укладки настенной плитки из белой глины.

Nettoyage extrêmement facile / Extrem einfache Reinigung / Máxima facilidad de limpieza / Предельная простота ухода

Nettoyage extrêmement facile / Extrem einfache Reinigung / Máxima facilidad de limpieza / Предельная простота ухода

Les carrelages céramiques en pâte blanche se nettoient simplement avec de l'eau chaude ou avec un détergent neutre. / Die weißscherbigen Keramikbeläge werden einfach durch Abwischen mit warmem Wasser oder einem neutralen Putzmittel gereinigt. / Los revestimientos cerámicos de pasta blanca se limpian pasando un trapo húmedo con agua caliente o detergente neutro. / Настенная плитка из белой глины очищается теплой водой или нейтральным моющим средством.

White-body wall tiles - Rectified monocaliber

Compliant with standards EN 14411 annex L group B111
 Compliant with standards ISO 13006 annex L group B111
 Conforme alla norma EN 14411 Appendice L gruppo B111
 Conforme alla norma ISO 13006 Appendice L gruppo B111

Rivestimenti in pasta bianca - Rettificato monocalibro

40x80 cm - 15³/₄"x31¹/₂"
 40x80 cm - 15³/₄"x31¹/₂"

± 8,5 mm
 ± 10 mm 3D Row



Technical features Caratteristiche tecniche	Test Method Metodo di prova	Requirements for nominal size N Requisiti per dimensione nominale N		
		7 cm ≤ N < 15 cm	N ≥ 15 cm	
		(mm)	(%)	(mm)
Length and width Lunghezza e larghezza	ISO 10545-2	± 0,75 ^(*)	± 0,5 ^(*)	± 2,0 ^(*)
Thickness Spessore		± 0,5 ^(**)	± 10 ^(**)	± 0,5 ^(**)
Straightness of sides Rettilinearità degli spigoli		± 0,5 ^(***)	± 0,3 ^(***)	± 1,5 ^(***)
Rectangularity Ortogonalità		± 0,75 ^(****)	± 0,5 ^(****)	± 2,0 ^(****)
Surface flatness Planarità	ISO 10545-2	c.c. + 0,75 - 0,50	c.c. + 0,5 - 0,3	c.c. + 2,0 - 1,5
		e.c. + 0,75 - 0,50	e.c. + 0,5 - 0,3	e.c. + 2,0 - 1,5
		w. ± 0,75	w. ± 0,5	w. ± 2,0
Water absorption (in % by mass) Massa d'acqua assorbita (come % della massa)	ISO 10545-3	Average >10%. When the average > 20%, this shall be indicated. Individual value > 9% Media >10%. Se questo valore > 20%, deve essere indicato. Valore Singolo > 9%		
Breaking strength Sforzo di rottura	ISO 10545-4	S ≥ 600 N		
Modulus of rupture Resistenza alla flessione		R ≥ 15 N/mm ²		
Coefficient of thermal linear expansion Coefficiente di dilatazione termica lineare	ISO 10545-8	Declared value Valore dichiarato		
Thermal shock resistance Resistenza agli sbalzi termici	ISO 10545-9	Pass according to EN ISO 10545-1 Test superato in accordo con ISO 10545-1		
Moisture expansion (in mm/m) Dilatazione all'umidità (in mm/m)	ISO 10545-10	Declared value Valore dichiarato		
Crazing resistance Resistenza al cavillo	ISO 10545-11	Pass according to EN ISO 10545-1 Test superato in accordo con ISO 10545-1		
Bond strength/adhesion for improved cementitious adhesives Adesione a trazione con adesivi cementizi migliorati	EN 1348	Declared value Valore dichiarato		
Reaction to fire Reazione al fuoco	-	Class A1 Classe A1		
Resistance to household chemicals and swimming pool salts Resistenza ai prodotti chimici di uso domestico ed agli additivi per piscina	ISO 10545-13	Minimum Class B (GB for glazed tiles) Classe minima B (GB per piastrelle smaltate)		
Resistance to low concentrations of acids and alkalis Resistenza a basse concentrazioni di acidi e alcali		Declared Class Classe dichiarata		
Resistance to high concentrations of acids and alkalis Resistenza ad alte concentrazioni di acidi e alcali		Declared Class Classe dichiarata		
Resistance to staining Resistenza alle macchie	ISO 10545-14	Minimum Class 3 Classe 3 minima		
Release of dangerous substances: Cadmium (in mg/dm²) and Lead (in mg/dm²) Rilascio di sostanze pericolose: Cadmio (in mg/dm ²) e Piombo (in mg/dm ²)	ISO 10545-15	Declared value Valore dichiarato		

^(*) The permissible deviation, in % or mm, of the average size for each tile (2 or 4 sides) from work size (WS). Deviazione ammissibile, in % oppure mm, della dimensione media di ogni piastrella (2 oppure 4 lati) dalla dimensione di fabbricazione (WS).
^(**) The permissible deviation, in % or mm, of the average thickness for each tile from the work size thickness (WS). Deviazione ammissibile, in % oppure mm, dello spessore medio di ogni piastrella dallo spessore riportato nella dimensione di fabbricazione (WS).
^(***) The maximum permissible deviation from straightness, in % or mm, related to the corresponding work sizes (WS). Deviazione massima ammissibile di rettilinearità, in % oppure mm, in rapporto alle dimensioni di fabbricazione (WS) corrispondenti.
^(****) The maximum permissible deviation from rectangularity, in % or mm, related to the corresponding work sizes (WS). Deviazione massima ammissibile di ortogonalità, in % oppure mm, in rapporto alle dimensioni di fabbricazione (WS) corrispondenti.
 c.c. The maximum permissible deviation from centre curvature, in % or mm, related to diagonal calculated from the work sizes (WS). Deviazione massima ammissibile della curvatura del centro, in % oppure mm, in rapporto alla diagonale calcolata secondo le dimensioni di fabbricazione (WS).
 e.c. The maximum permissible deviation from edge curvature, in % or mm, related to the corresponding work sizes (WS). Deviazione massima ammissibile della curvatura dello spigolo, in % oppure mm, in rapporto alle dimensioni di fabbricazione (WS) corrispondenti.
 w. The maximum permissible deviation from warpage, in % or mm, related to diagonal calculated from the work sizes (WS). Deviazione massima ammissibile dello svergolamento, in % oppure mm, in rapporto alla diagonale calcolata secondo le dimensioni di fabbricazione (WS).

Wall tiles

± 0,3% ± 1,0 mm	3D Not applicable Non applicabile
± 10,0% ± 0,5 mm	
± 0,3% ± 0,8 mm	
± 0,3% ± 1,5 mm	
± 0,3% ± 1,5 mm	3D Not applicable Non applicabile
10% < E _v ≤ 20 %	
S ≥ 600 N	
R ≥ 15 N/mm ²	
≤ 7MK ⁻¹	
Resistant Resiste	
≤ 0,06% (0,6mm/m)	
Resistant Resiste	
≥ 1,0 N/mm ² (Class C2 - EN 12004)	
A1	
A	
LA	
HA	
5	
≤ 0,01 mg/dm ² Cd ≤ 0,1 mg/dm ² Pb	

Coloured body porcelain tiles - Rectified monocaliber

Compliant with standards EN 14411 annex G group B1a
 Compliant with standards ISO 13006 annex G group B1a
 Conforme alla norma EN 14411 Appendice G gruppo B1a
 Conforme alla norma ISO 13006 Appendice G gruppo B1a

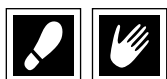

Technical features Caratteristiche tecniche	Test Method Metodo di prova	Requirements for nominal size N / Requisiti per dimensione nominale N		
		7 cm ≤ N < 15 cm	N ≥ 15 cm	
		(mm)	(%)	(mm)
Length and width Lunghezza e larghezza	ISO 10545-2	± 0,9 ^(*)	± 0,6 ^(*)	± 2,0 ^(*)
Thickness Spessore		± 0,5 ^(**)	± 5 ^(**)	± 0,5 ^(**)
Straightness of sides Rettilinearità degli spigoli		± 0,75 ^(***)	± 0,5 ^(***)	± 1,5 ^(***)
Rectangularity (Measurement only on short edges when L/1 ≥ 3) Ortogonalità (Misurazione da condurre solo sui lati corti quando L/1 ≥ 3)		± 0,75 ^(****)	± 0,5 ^(****)	± 2,0 ^(****)
Surface flatness Planarità	ISO 10545-2	c.c. ± 0,75	c.c. ± 0,5	c.c. ± 2,0
		e.c. ± 0,75	e.c. ± 0,5	e.c. ± 2,0
		w. ± 0,75	w. ± 0,5	w. ± 2,0
Water absorption (in % by mass) Massa d'acqua assorbita (come % della massa)	ISO 10545-3	E _v ≥ 0,5% Individual Maximum 0,6% E _v ≤ 0,5% Valore massimo singolo 0,6%		
	ASTM C 373	Requirement ANSI A137.1-2017 Water absorption max ≤ 0,5%		
Breaking strength Sforzo di rottura	ISO 10545-4	S ≥ 700N (for thickness < 7,5 mm - per spessore < 7,5 mm) S ≥ 1300N (for thickness ≥ 7,5 mm - per spessore ≥ 7,5 mm)		
Modulus of rupture Resistenza alla flessione		R ≥ 35 N/mm ²		
Bending strength and breaking load Resistenza a flessione e al carico di rottura (4/5)	EN 1339 Annex F	-		
Impact resistance, as coefficient of restitution Resistenza all'impatto, espresso come coefficiente di restituzione	ISO 10545-5	Declared value Valore dichiarato		
Mohs hardness Durezza Mohs	EN 101	-		
Resistance to deep abrasion of unglazed tiles (removed volume) Resistenza all'abrasione profonda delle piastrelle non smaltate (volume materiale asportato)	ISO 10545-6	≤ 175 mm ³		
Coefficient of thermal linear expansion Coefficiente di dilatazione termica lineare	ISO 10545-8	Declared value Valore dichiarato		
Thermal shock resistance Resistenza agli sbalzi termici	ISO 10545-9	Pass according to EN ISO 10545-1 Test superato in accordo con ISO 10545-1		
Moisture expansion (in mm/m) Dilatazione all'umidità (in mm/m)	ISO 10545-10	Declared value Valore dichiarato		
Frost resistance Resistenza al gelo	ISO 10545-12	Pass according to EN ISO 10545-1 Test superato in accordo con ISO 10545-1		
Bond strength/adhesion for improved cementitious adhesives Adesione a trazione con adesivi cementizi migliorati	EN 1348	Declared value Valore dichiarato		
Reaction to fire Reazione al fuoco	-	Class A1 or A1 _F Classe A1 oppure A1 _F		
Resistance to household chemicals and swimming pool salts Resistenza ai prodotti chimici di uso domestico ed agli additivi per piscina	ISO 10545-13	Minimum Class B Classe minima B		
Resistance to low concentrations of acids and alkalis Resistenza a basse concentrazioni di acidi e alcali		Declared Class Classe dichiarata		
Resistance to high concentrations of acids and alkalis Resistenza ad alte concentrazioni di acidi e alcali		Declared Class Classe dichiarata		
Resistance to staining Resistenza alle macchie	ISO 10545-14	Declared Class Classe dichiarata		
Shod Ramp Test Metodo della rampa "calzato"	DIN 51130	Declared value Valore dichiarato		
Barefoot Ramp Test Metodo della rampa a piedi nudi	DIN 51097	Declared value Valore dichiarato		
Pendulum Friction Test Metodo del Pendolo	BS 7976	PTV ≥ 36 classifies the surface as "low slip risk"		
Pendulum Friction Test Metodo del Pendolo	AS 4586	Declared Classification of the new pedestrian surface materials according to the Pendulum Test		
Pendulum Friction Test Metodo del Pendolo	UNE-ENV 12633	Declared value Valore dichiarato		
Coefficient of friction (COF) Coefficiente di attrito	B.C.R.A. Rep. CEC/81	D. M. 236/89 del 14/06/89 μ > 0,40 per elemento scivolante cuoio su pavimentazione asciutta μ > 0,40 per elemento scivolante gomma dura su pavimentazione bagnata		
Dynamic coefficient of friction (DCOF) Coefficiente di attrito dinamico	ANSI A137.1	ANSI A.137.1-2017 Requires a minimum value of 0.42 for level interior space expected to be walked upon when wet. (3)		

^(*) The permissible deviation, in % or mm, of the average size for each tile (2 or 4 sides) from work size (WS). Deviazione ammissibile, in % oppure mm, della dimensione media di ogni piastrella (2 oppure 4 lati) dalla dimensione di fabbricazione (WS).
^(**) The permissible deviation, in % or mm, of the average thickness for each tile from the work size thickness (WS). Deviazione ammissibile, in % oppure mm, dello spessore medio di ogni piastrella dallo spessore riportato nella dimensione di fabbricazione (WS).
^(***) The maximum permissible deviation from straightness, in % or mm, related to the corresponding work sizes (WS). Deviazione massima ammissibile di rettilinearità, in % oppure mm, in rapporto alle dimensioni di fabbricazione (WS) corrispondenti.
^(****) The maximum permissible deviation from rectangularity, in % or mm, related to the corresponding work sizes (WS). Deviazione massima ammissibile di ortogonalità, in % oppure mm, in rapporto alle dimensioni di fabbricazione (WS) corrispondenti.
 c.c. The maximum permissible deviation from centre curvature, in % or mm, related to diagonal calculated from the work sizes (WS). Deviazione massima ammissibile della curvatura del centro, in % oppure mm, in rapporto alla diagonale calcolata secondo le dimensioni di fabbricazione (WS).
 e.c. The maximum permissible deviation from edge curvature, in % or mm, related to the corresponding work sizes (WS). Deviazione massima ammissibile della curvatura dello spigolo, in % oppure mm, in rapporto alle dimensioni di fabbricazione (WS) corrispondenti.
 w. The maximum permissible deviation from warpage, in % or mm, related to diagonal calculated from the work sizes (WS). Deviazione massima ammissibile dello svergolamento, in % oppure mm, in rapporto alla diagonale calcolata secondo le dimensioni di fabbricazione (WS).
 (1). Determination of slip resistance of pedestrian surfaces; it does not cover sports surfaces and road surfaces for vehicles (skid resistance). Determinazione della resistenza allo scivolamento delle superfici pedonabili; non si applica alle pavimentazioni sportive ed alle pavimentazioni stradali veicolari.
 (2). Anti-slip performance is guaranteed at the time of delivery of the product. Le prestazioni anti-slip vengono garantite al momento della consegna del prodotto.
 (3). However, tiles with a DCOF of 0.42 or greater are not necessarily suitable for all projects. The specifier shall determine tiles appropriate for specific project conditions, considering by way of example, but not in limitation, type of use, traffic, expected contaminants, expected maintenance, expected wear, and manufacturers' guidelines and recommendations.
 (4). For further details, please refer to outdoor design general catalogue. Per maggiori informazioni riferirsi al catalogo generale Outdoor Design.
 (5). Only for products with 20 mm thickness. Solo per prodotti a 20mm di spessore.

Gres porcellanato colorato in massa - Rettificato monocalibro

90x90 cm - 35³/₈"x35³/₈"
 45x90 cm - 17³/₈"x35³/₈"
 60x60 cm - 23³/₈"x23³/₈"

± 9 mm
 ± 9 mm
 ± 9 mm

± 20 mm
 ± 20 mm
 ± 20 mm

Porcelain tiles		
Matte	Grip	Outdoor Paving ± 20 mm
± 0,3% ± 1,0 mm	± 0,3% ± 1,0 mm	± 0,3% ± 1,0 mm
± 5,0% ± 0,5 mm	± 5,0% ± 0,5 mm	± 5,0% ± 0,5 mm
± 0,3% ± 0,8 mm	± 0,3% ± 0,8 mm	± 0,3% ± 0,8 mm
± 0,3% ± 1,5 mm	± 0,3% ± 1,5 mm	± 0,3% ± 1,5 mm
Not applicable to "strong" structures Non applicabile a strutturati forti		
≤ 0,1 %	≤ 0,1 %	≤ 0,1 %
≤ 0,5 %	≤ 0,5 %	≤ 0,5 %
S ≥ 1500 N	S ≥ 1500 N	S ≥ 10000 N
R ≥ 40 N/mm ²	R ≥ 40 N/mm ²	R ≥ 45 N/mm ²
-	-	≥ T11 60x60 90x90
≥ U4	≥ U4	≥ U4
≥ 0,55	≥ 0,55	≥ 0,55
7	8	8
≤ 150 mm ³	≤ 150 mm ³	≤ 150 mm ³
≤ 7MK ⁻¹	≤ 7MK ⁻¹	≤ 7MK ⁻¹
Resistant Resiste	Resistant Resiste	Resistant Resiste
≤ 0,01% (0,1mm/m)	≤ 0,01% (0,1mm/m)	≤ 0,01% (0,1mm/m)
Resistant Resiste	Resistant Resiste	Resistant Resiste
≥ 1,0 N/mm ² (Class C2 - EN 12004)	≥ 1,0 N/mm ² (Class C2 - EN 12004)	≥ 1,0 N/mm ² (Class C2 - EN 12004)
A1 - A1 _F	A1 - A1 _F	A1 - A1 _F
A	A	A
LA	LA	LA
HA	HA	HA
5	5	5
R10	R11	R11
A+B	A+B+C	A+B+C
≥ 36 Dry ≥ 36 Wet	≥ 36 Dry ≥ 36 Wet	≥ 36 Dry ≥ 36 Wet
Class P3	Class P4	Class P4
Class C2	Class C3	Class C3
> 0,40 Asciutto > 0,40 Bagnato	> 0,40 Asciutto > 0,40 Bagnato	> 0,40 Asciutto > 0,40 Bagnato
> 0,42 Wet	> 0,42 Wet	> 0,42 Wet

Green Project

Sustainability / Sostenibilità

In the environmental and economic sciences, sustainability is defined as the condition of development capable of ensuring the satisfaction of the needs of the present generation without compromising the ability of future generations to realize their own. Several international certifications guarantee that the Atlas Concorde products meet the criteria of sustainable construction, attesting to their low impact on the ecosystem, compliance with declared standards and attention to comfort.

Nelle scienze ambientali ed economiche, la sostenibilità è definita come condizione di uno sviluppo in grado di assicurare il soddisfacimento dei bisogni della generazione presente senza compromettere la possibilità delle generazioni future di realizzare i propri. Diverse certificazioni internazionali garantiscono che i prodotti Atlas Concorde rispondono ai criteri del costruire sostenibile, attestandone il basso impatto sull'ecosistema, la conformità agli standard dichiarati e l'attenzione al comfort abitativo.

Certifications / Certificazioni



ISO 9001

In 1995 Atlas Concorde obtained ISO 9001 quality certification for its products. It is an international recognition referring to the company's entire quality system, from the receipt of raw materials to their transformation, from the distribution of the product to their placement on the market.

Sin dal 1995 Atlas Concorde ha ottenuto per i propri prodotti la certificazione di qualità ISO 9001. Si tratta di un riconoscimento internazionale riferito all'intero sistema di qualità aziendale, dall'ingresso delle materie prime alla loro trasformazione, dalla distribuzione del prodotto alla sua immissione sul mercato.

LEED V4*

All Atlas Concorde porcelain floor and white body wall tiles can be used in projects that follow the guidelines of the GREEN BUILDING COUNCIL, which promotes the independent certification system LEED BD&C v4 (Leadership in Energy and Environmental Design, Building Design & Construction), whose parameters establish precise criteria for the design and construction of buildings that are healthy, energy efficient and with low environmental impact. All our products in porcelain stoneware and in white clay can therefore contribute to obtaining the LEED V4 rating of buildings, in relation to different areas: Sustainable Sites, Materials and Resources, Internal Environmental Quality.

Tutti i prodotti in gres porcellanato e in pasta bianca Atlas Concorde possono essere utilizzati in progetti che seguono le linee guida del GREEN BUILDING COUNCIL, che promuove il sistema di certificazione indipendente LEED BD&C v4 (Leadership in Energy and Environmental Design, Building Design & Construction), i cui parametri stabiliscono precisi criteri di progettazione e realizzazione di edifici salubri, energeticamente efficienti e a impatto ambientale contenuto. Tutti i nostri prodotti in gres porcellanato e in pasta bianca possono quindi contribuire all'ottenimento del rating LEED V4 degli edifici, relativamente diverse aree tematiche: Siti Sostenibili, Materiali e Risorse, Qualità ambientale Interna.

EPD

Atlas Concorde also has an EPD declaration, which attests to the environmental sustainability of its products. The EPD (Environmental Product Declaration) also assesses the life cycle of a product, from extraction to production, transport, installation, maintenance, and cleaning. Atlas Concorde's EPD declaration was certified by the independent certifying body EPD ITALY.

Atlas Concorde dispone inoltre di una dichiarazione EPD, che attesta la sostenibilità ambientale dei prodotti. Anche la EPD (Environmental Product Declaration) valuta il ciclo di vita di un prodotto, dall'estrazione all'utilizzo passando per la produzione, il trasporto, l'installazione, la manutenzione e la pulizia. La dichiarazione EPD di Atlas Concorde è stata certificata dall'ente di certificazione indipendente EPD ITALY.

PEF*

The environmental footprint of products (PEF, Product Environmental Footprint, according to Recommendation 2013/179/EU) is a measurement that, based on various criteria, indicates the environmental performance of a product or service over its lifetime, taking into account supply chain activities: from the extraction of raw materials, to the production, use, and end of life of the product. Atlas Concorde has a verified PEF. Atlas Concorde's PEF was verified by the DNV-GL certifying body.

L'impronta ambientale dei prodotti (PEF, Product Environmental Footprint, secondo la Raccomandazione 2013/179/UE) è una misura che, sulla base di vari criteri, indica le prestazioni ambientali di un prodotto o servizio nel corso del proprio ciclo di vita, tenendo conto delle attività della catena di approvvigionamento: dall'estrazione di materie prime, alla produzione, all'uso e fine vita del prodotto. Atlas Concorde dispone di una PEF verificata. La PEF di Atlas Concorde è verificata dall'organismo di certificazione DNV-GL.

FDES*

Atlas Concorde has also drafted an FDES environmental declaration (Fiche de déclaration environnementale et sanitaire), this also having the purpose of transparently disclosing the product's impact, covering each phase from product extraction to production and finally laying and use.

Atlas Concorde ha realizzato inoltre la dichiarazione ambientale FDES (Fiche de déclaration environnementale et sanitaire), anch'essa con lo scopo di rendicontare in modo trasparente l'impatto del prodotto, a partire dalla fase di estrazione del prodotto, passando dalla fase di produzione, fino alla posa ed all'utilizzo.

HPD

Atlas Concorde has a HPD (Health Product Declaration) declaration, a complete report on the health characteristics of the finished product, compiled according to the HPD standard.

Atlas Concorde dispone della dichiarazione HPD (Health Product Declaration), un report completo sulle caratteristiche di salubrità del prodotto finito, compilato secondo lo standard HPD.

CAM/ISO 14021

An environmental declaration according to the ISO 14021 international standard, observance of Minimum Environmental Criteria, and the adoption of sustainability policies demonstrate Atlas Concorde's attention to environmental issues and allow the inclusion of its products in Green Public Tenders.

La dichiarazione ambientale secondo lo standard internazionale ISO 14021 ed il rispetto dei requisiti dei Criteri Ambientali Minimi permette ad Atlas Concorde, grazie all'adozione di politiche di sostenibilità, di dimostrare l'attenzione alle problematiche ambientali e proporre l'inserimento dei propri prodotti negli Appalti Pubblici Verdi.

For further details, please refer to / Per ulteriori dettagli, fare riferimento a: atlasconcorde.com



MADE IN ITALY. MADE TO EXCEL.

MADE IN ITALY

The Made in Italy logo of Atlas Concorde stands for style, quality and ethics. Having firmly adhered to the Ethical Code promoted by Confindustria Ceramica, Atlas Concorde places the Made in Italy logo on all the products designed and produced in Italy, that is to say ceramic tiles, decorations and the majority of special trim tiles. Only a small amount of the latter is manufactured in Spain. Atlas Concorde products are produced using eco-friendly technologies, top quality and safe raw materials with the best working conditions guaranteed for our personnel. For these reasons, Atlas Concorde's Made in Italy is the expression of strong values such as style, design, product quality, and respect for the environment and the people who live in it.

Il marchio Made in Italy di Atlas Concorde è sinonimo di stile, qualità ed etica. Avendo aderito con convinzione al Codice Etico di Confindustria Ceramica, Atlas Concorde appone il marchio Made in Italy su tutti i prodotti studiati, progettati e realizzati in Italia, nella fattispecie tutte le piastrelle di ceramica, le decorazioni e la maggioranza dei pezzi speciali. Solo un ristretto numero di questi ultimi è fabbricato in Spagna. I prodotti Atlas Concorde sono inoltre realizzati con tecnologie rispettose dell'ambiente, utilizzando materie prime eccellenti e sicure, garantendo le migliori condizioni di lavoro. Per queste ragioni il Made in Italy di Atlas Concorde è espressione di valori forti quali stile, design, qualità del prodotto, attenzione all'ambiente e alle persone.



The Ceramics of Italy logo is an exclusive identification on ceramic products which have effectively been made in Italy by companies that are a part of the Confindustria Ceramica and who adhered to its Ethical Code. This Code, promoted and created by Confindustria Ceramica, commits all companies to communicate, clearly and with transparency, the origin of their products.

Il marchio Ceramics of Italy contrassegna esclusivamente i prodotti ceramici effettivamente realizzati in Italia da un'azienda associata a Confindustria Ceramica che ha sottoscritto il Codice Etico. Il Codice, redatto dalla stessa Confindustria Ceramica, impegna a comunicare con chiarezza l'origine dei prodotti.

www.ceramica.info

CERAMICHE ATLAS CONCORDE S.p.A.
Via Canaletto 141
41042 Spezzano di Fiorano (MO) - Italia

ATLAS CONCORDE USA, Inc.
117 Seaboard Lane - Suite 170
Franklin, TN 37067 - USA

ATLAS CONCORDE RUSSIA
Business centre "Meliora Place"
Prospekt Mira 6, 129090 Moscow - Russia

atlasconcorde.com



Copyright 2019 by Ceramiche Atlas Concorde S.p.A.
(Spezzano di Fiorano, MO - Italy)
April 2019